

**DIGITAL
YACHT**

**DIGITAL
DEEP SEA**



SAIL BOAT

SPORT FISHING

MOTOR BOAT



NAVAL

COMMERCIAL
FISHING

COMMERCIAL
SHIPPING

SUPERYACHT

WORK BOAT

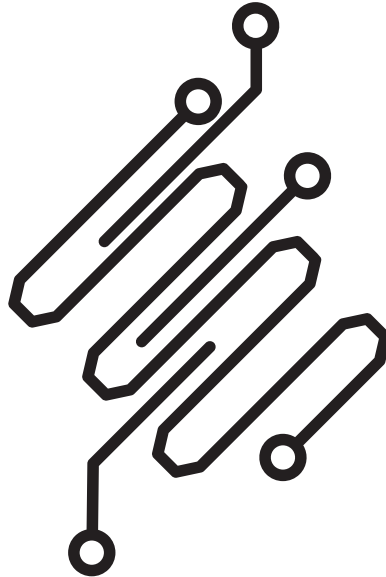

PRODUCT GUIDE 2015

US Market USD / \$

Tel: 978 277 1234
www.digitalyachtamerica.com
Edition 1 | 2015

AIS

NAVIGATION

**WIRELESS
NAVIGATION**

**WIRELESS
INTERNET**

MARINE PCs

**ONBOARD
ENTERTAINMENT**

SOFTWARE

BOAT_{RA}NET

**DIGITAL
DEEP SEA**

DIGITAL YACHT 2015 IS ALL ABOUT NEXT GENERATION NAVIGATION, COMMUNICATION AND ENTERTAINMENT SYSTEMS FOR YOUR BOAT. BOATING SHOULD BE FUN, SAFE AND EASY AND OUR PRODUCTS INTEGRATE INTO EXISTING AND NEW BOAT NETWORKS TO BRING A POWERFUL DIMENSION TO YOUR ON-BOARD ELECTRONICS.

We firmly believe that low cost consumer devices such as iPhones and tablets, PCs and MACs have a place on board and can help make legacy systems compete with the latest in dedicated marine electronic products at a fraction of the cost. We make internet access whilst afloat easy and affordable as well as bringing all your navigation data to your favourite consumer devices - not just for you but for crew and guests too.

Our navigation systems cover advanced GPS and compass technology as well as the most comprehensive range of AIS products in the marketplace. Plus our PC and software solutions bring simple yet powerful solutions to a variety of on board requirements from communication to navigation, entertainment to monitoring.

Our design team has 100's years combined experience in marine electronic systems and we take pride in our quality heritage with manufacturing in the UK and global reach with offices in the US and China. Last year our products were sold in over 100 countries worldwide.

Good Boating,



Nick Heyes

AIS100 RECEIVER (NMEA 0183)



Typical system

“Connects to any NMEA AIS compatible chart plotter and adds an AIS overlay. Simple to install, highly sensitive dual channel design that’s easy to install with Garmin, Raymarine, Standard, Lowrance, Simrad, Furuno etc plotters”

KEY FEATURES

This value priced, entry level AIS receiver is Digital Yacht’s most cost effective solution for adding AIS to your boat. Featuring the same dual channel receiver as the AIS100Pro, but without the USB interface and multiplexer, there is no compromise on performance and the AIS100 will out-perform all other, inferior, single channel receivers.

For use with existing AIS compatible chart plotters, such as the latest Garmin, Raymarine, Navico, Standard Horizon and Furuno units. Typical AIS reception range is 20 – 20 m for a mast top antenna.

SPECIFICATIONS

- Low cost entry level AIS receiver
- High performance dual-channel AIS receiver for use with existing plotter and radar systems
- High speed NMEA output (38,400 baud)
- Requires VHF antenna or dedicated AIS antenna (available as optional accessory) or splitter
- Easy to install IP54 black box solution
- BNC antenna connector

EXTRA APPLICATIONS

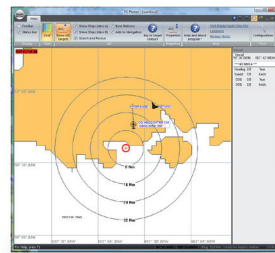

All Digital Yacht systems ship with SmarterTrack Lite PC software



Use the SPL2000 VHF – AIS antenna splitter to share the vessels VHF antenna with VHF and AIS.

DIMENSIONS

105mm x 72mm x 32mm
(L x W x D)

PART NUMBER

ZDIGAIS100
UPC
738435472382

SUPPLIED WITH

Integral mounting brackets, 0.75m Power/Data cable, AIS Lite software on CD and User Manual

PRICE

\$ 239.95



AIS



INTERFACE

AIS100 RECEIVER (USB)

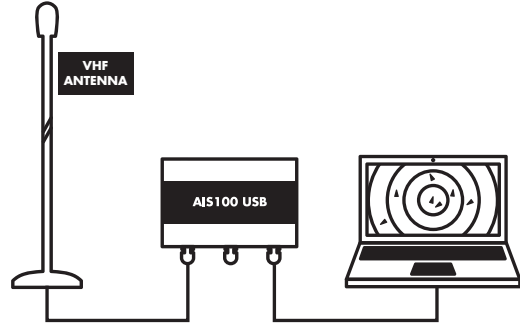

Typical system

“Perfect for PC based navigation systems with USB drivers for PC, MAC and linux”

KEY FEATURES

This value priced, entry level AIS receiver is Digital Yacht’s most cost effective solution for getting AIS on your PC. Featuring the same dual channel receiver as the AIS100Pro, but without the NMEA 0183 Output and multiplexer, there is no compromise on performance and the AIS100USB will out-perform all other, inferior, single channel receivers.

Simple plug and play USB connection to a PC. Uses standard drivers built-in to Windows XP/Vista/7 and is automatically mapped to an available “virtual” com port, which your PC software can read. Also compatible with Mac OS X and all LINUX Kernels since V2.4.20.

For use with any AIS compatible PC navigation software, such as the latest SmarterTrack, MaxSea, SeaPro, Nobeltec and Rose-Point applications.

SPECIFICATIONS

- Low cost entry level AIS receiver
- High performance dual-channel AIS receiver for use with AIS compatible PC navigation software
- USB Interface for simple Plug and Play connection to a PC
- Requires VHF / AIS antenna or splitter
- Easy to install IP54 black box solution

EXTRA APPLICATIONS

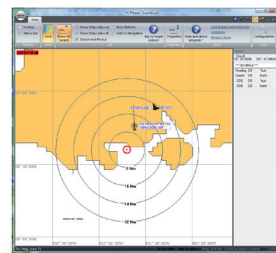

All Digital Yacht systems ship with SmarterTrack Lite PC software



Use the SPL2000 VHF — AIS antenna splitter to share the vessels VHF antenna with VHF and AIS.

DIMENSIONS

105mm x 72mm x 32mm
(L x W x D)

PART NUMBER

ZDIGAIS100USB
UPC
738435472399

SUPPLIED WITH

Integral mounting brackets, 0.75m Power cable, 0.75m USB cable, AIS Lite software on CD and User Manual

PRICE

\$ 239.95



AIS



USB



LINUX



MAC



WINDOWS 8

AIS100PRO RECEIVER (NMEA & USB)



Typical system

“Combination NMEA and USB connections for PC and plotter based systems. Also features NMEA input and inbuilt multiplexer”

KEY FEATURES

Great entry-level AIS receiver for use with PC navigation software and chart plotters, such as the latest Garmin, Raymarine, Navico, Standard Horizon and Furuno units. Connected to an existing VHF antenna (via a splitter) or dedicated AIS antenna, you can receive all AIS targets within range – typically up to 30nm. Simple plug and play USB connection to a PC. Uses standard drivers built-in to Windows XP/Vista/7 and is automatically mapped to an available “virtual” com port, which your PC software can read. Also compatible with Mac OS X and all LINUX Kernels since V2.4.20.

The AIS100 Pro has a dual NMEA0183 and USB output capability, allowing you to supply AIS data to a PC (via USB) and a dedicated plotter (via NMEA) for larger installations.

Connect the NMEA (4800 baud) output of your GPS to the AIS100Pro and it will automatically multiplex (merge) the slower GPS data with the high speed AIS data and transmit everything on the high speed NMEA output (38,400 baud) - perfect for connection to a chart plotter with only one NMEA input.

SPECIFICATIONS

- High performance dual channel AIS receiver for use with existing plotter and radar systems
- USB Interface for simple plug ‘n play connection to a PC
- High Speed NMEA output (38,400 baud)
- Requires VHF antenna or dedicated AIS antenna (available as optional accessory) or splitter
- Multiplexed NMEA input for single NMEA GPS+AIS data output at 38,400 baud
- Easy to install IP54 black box solution

EXTRA APPLICATIONS

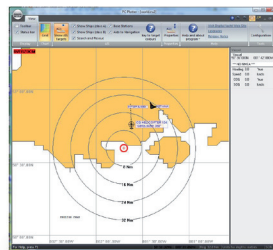

All Digital Yacht systems ship with SmarterTrack Lite PC software



Use the SPL2000 VHF — AIS antenna splitter to share the vessels VHF antenna with VHF and AIS.

DIMENSIONS

105mm x 72mm x 32mm
(L x W x D)

PART NUMBER

ZDIGAIS100P
UPC
030955183657

SUPPLIED WITH

Integral mounting brackets, 0.75m Power/Data cable, 0.75m USB cable, AIS Lite software on CD and User Manual

PRICE

\$ 279.95



AIS



USB



INTERFACE



MULTIPLEXER



LINUX



MAC



WINDOWS 8

AISNODE

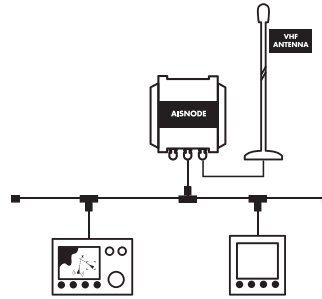

Typical system

“AISnode Brings Simple AIS Installation To NMEA2000 Networks”

KEY FEATURES

Many modern on board electronic system now utilise the NMEA2000 interfacing standard to allow inter-connectivity and interfacing between systems. It’s an easy plug ‘n play solution that allows reliable on board data sharing with simple common connectors. NMEA 2000 devices connect on a cabled “backbone” with a “T-connector” used to spur off to each device.

Digital Yacht have just introduced AISnode – an AIS receiver with an NMEA2000 interface allowing AIS data to – e shared across plotters, radars or other compatible devices on board. It’s simple to fit too with power for this low wattage device taken direct from the NMEA2000 bus so there’s no need for separate power supply. Just connect to a VHF antenna or suitable VHF antenna splitter (for a shared antenna) and there’s AIS data available for the plotter display. Once connected, you’ll see an overlay of targets around you with drill down data on the vessels identity, position, course and speed as well as closest point of approach.

The new AISnode exploits Digital Yacht’s sensitive dual channel receiver technology for excellent target reception range and ability to process all the latest types of AIS targets like ATONs and SARTs.

Class A and Class B targets are also fully decoded with all the relevant static and voyage data.

SPECIFICATIONS

- NMEA 2000 connectivity
- Self-powered from NMEA 2000 network
- Supplied with 1m NMEA 2000 cable
- High sensitivity dual channel design
- Decodes all the latest AIS target types including ATONs and SARTs

DIMENSIONS

160mm x 120mm
(L x W)

PART NUMBER

ZDIGAISNODE
UPC
081159830403

SUPPLIED WITH

Supplied with 0.8m NMEA 2000
drop cable

PRICE

\$399.95



AIS



INTERFACE

iAIS RECEIVER

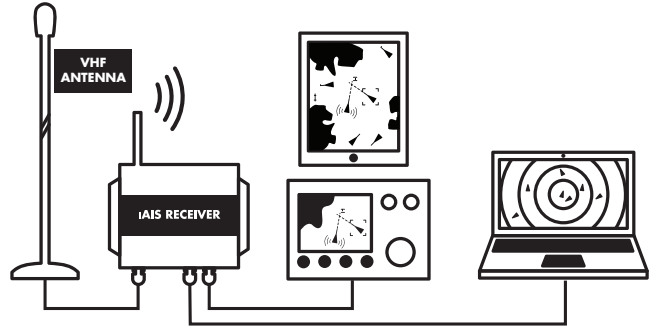

Typical system

“Award winning AIS receiver with wireless interface. Connect to your plotter, PC and mobile device through a wireless interface. Turns your iPhone or iPad into a full function AIS display and now also compatible with apps for Android too.”

KEY FEATURES

The world's first wireless AIS receiver that links wirelessly with the latest iPhone, iPad and iTouch devices. Consisting of a high performance dual channel AIS receiver, an integrated 802.11b+g wireless access point plus a free app downloadable from the Apple App Store, the iAIS brings AIS data to a whole new generation of mobile devices.

iAIS also multiplexes any other NMEA data that is available on board the boat - for instance GPS, depth, speed and wind etc. All of this data is combined with the AIS data into a single wireless feed, that becomes available on any compatible application. By using the boat's own GPS, even an iTouch or iPad that does not have an internal GPS can now be used for navigation and superior performance will also be seen on an iPhone, which some users have complained suffers from jitter or poor lock-on with its internal GPS.

As well as sending data wirelessly, the iAIS also has an NMEA0183 and USB interface so that you can output data to a PC (via USB) and a dedicated plotter (via NMEA) for larger installations.

The free iAIS app is available from the App store and is a simple AIS display program. For more advanced use, Digital Yacht recommends the iNavX app (www.inavx.com). Now supports TCP/IP and UDP connection for multiple uses.

SPECIFICATIONS

- World's first wireless AIS and NMEA Data server
- Tri-output; WiFi, NMEA 0183 and USB
- Multiplexed NMEA input for wireless NMEA data feed of boat's instrument and GPS data
- TCP & UDP connectivity
- Free iAIS App for iPhone, iTouch or iPad
- Integrated 802.11b+g wireless access point
- Fully compatible with popular iNavX navigation application for Apple mobile devices
- Rugged IPX5 aluminium housing
- Requires VHF antenna or dedicated AIS antenna (available as optional accessory) or splitter
- Simple "fit and forget" black box solution

DIMENSIONS

150mm x 150mm x 37.5mm
(L x W x D)

PART NUMBER

ZDIGiAIS
UPC
738435472375

SUPPLIED WITH

Mounting brackets, 1m Power/Data cable, 1m USB Cable, iAIS app (from Apple App Store), software CD and User Manual

PRICE

\$ 549.95



AIS



USB



INTERFACE



WIRELESS



MULTIPLEXER



WINDOWS 8



LINUX



MAC



IOS



ANDROID

AISNET INTERNET BASE STATION

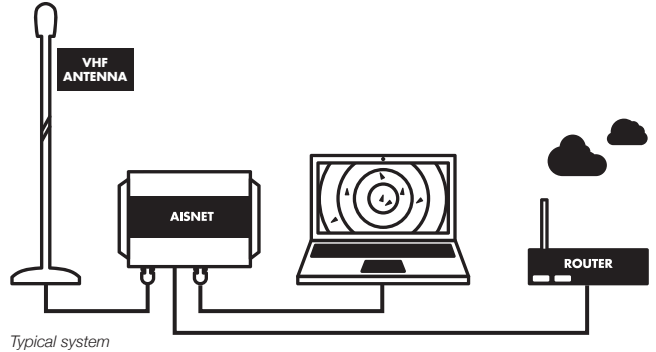

“Network enabled AIS receiver for base station operation. Simple RJ45 network interface and USB too. Perfect for use with Marine Traffic or AIS Live”

KEY FEATURES

AISnet is a new AIS base station receiver for use at home or in the office. Utilising the same high performance dual channel AIS receiver as the rest of the Digital Yacht range, AISnet also features an ethernet socket that can connect to a broadband router to send data to online AIS tracking services.

There are now a large number of internet based web sites, which offer a view of AIS equipped vessels on a background chart allowing users to check the position and identity of ships and yachts. If your home/office is close to the coast you can contribute your data to one of these sites, simply register with the company and they will give you an IP address and port number.

Using the setup program that Digital Yacht supply, it takes seconds to program the IP address and port into AISnet, which will immediately start sending your local AIS data seamlessly across the internet to be displayed on the site.

Data that AISnet is collecting, can also be viewed locally on your PC using the free SmarterTrack Lite software. Plug the USB

connector into your PC and AIS data will appear on your PC, whilst also transmitting over the internet.

AISnet is supplied with a universal UK/Euro/US mains adaptor that provides a regulated 12v supply from 240v/110v AC mains.

SPECIFICATIONS

- AIS base station for home or office use
- Integrated ethernet network controller for supplying AIS data to online AIS websites
- High performance dual channel AIS receiver
- Simple configuration via free setup program
- USB Interface for simple plug and play connection to a local PC
- Requires VHF antenna or dedicated AIS antenna (available as optional accessory) or splitter
- Universal Mains power supply included
- Simple “fit and forget” black box solution

DIMENSIONS

244mm x 150mm x 60.5mm
(L x W x D)

PART NUMBER

ZDIGAISNET
UPC
738435472429

SUPPLIED WITH

UK/Euro/US mains adaptor, 1m
USB Cable, AIS Lite + Setup
software on CD and User Manual

PRICE

\$ 499.95



AIS



USB



NETWORK



WINDOWS 8



LINUX



MAC

ANT200 RECEIVER

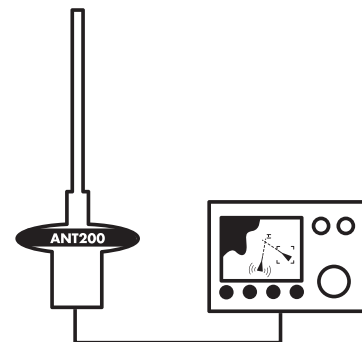

Typical system

“The AIS Smart Antenna – Mount ‘n connect AIS sensor with integrated antenna. Standard NMEA plotter compatible output”

KEY FEATURES

Perfect “all in one” AIS Smart Antenna solution for small boats, particularly RIBs, sports boats and small yachts, where dry space to mount black box AIS units is limited. Simply connect 12v or 24v power and the ANT200 will start transmitting data on all AIS targets within range of your boat – typically 10-15NM*. Ideal for use with existing AIS compatible chart plotters, such as the latest Garmin, Raymarine, Navico, Standard Horizon and Furuno units.

Connect the NMEA0183 (4800 baud) output of your GPS to the ANT200 and it will automatically multiplex (merge) the slower GPS data with the high speed AIS data and transmit everything on one high speed NMEA output (38,400 baud) - perfect for connection to a chart plotter with only one NMEA input.

* NOTE – similar to hand-held VHF’s, which have a reduced range compared to fixed mount VHF’s (no antenna ground plane), the ANT200 does not have the same range as the AIS100/200 black box AIS units. If maximum AIS range is your highest priority then one of the other Digital Yacht receivers should be used, but for small boats with the aerial mounted at deck level, 10 miles is a good range for AIS and the ANT200 is recommended.

SPECIFICATIONS

- World’s first AIS smart antenna
- Multiplexed NMEA input for single NMEA GPS+AIS data output at 38,400 baud
- Simple to install “all in one” smart antenna solution
- Integral 1” x 14 TPI thread for fixing to standard VHF mounts
- 15m power/data cable
- High performance dual channel AIS receiver for use with existing plotter and radar systems
- High speed NMEA output (38,400 baud)

DIMENSIONS

180mm x 100mm
(H x W)

PART NUMBER

ZDIGANT200
UPC
738435472597

SUPPLIED WITH

15m Power/Data cable and User Manual. AIS Lite included

PRICE

\$ 349.95



AIS



INTERFACE



MULTIPLEXER

uAIS RECEIVER

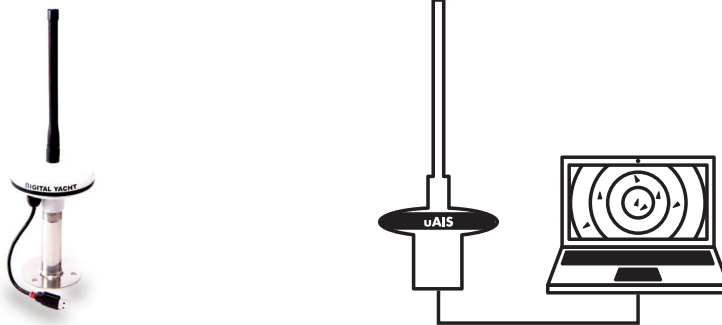

Typical system

“Self-powered AIS sensor with integrated antenna. Connects direct to PC USB port. Ideal for charter use with PC navigation programs”

KEY FEATURES

Perfect “all in one” AIS Smart Antenna solution for anyone using a Laptop on a small boat that wants to receive AIS data.

Simple plug and play USB connection to a PC. Uses standard drivers built-in to Windows XP/Vista/7 and is automatically mapped to an available “virtual” com port, which your PC software can read. Also compatible with Mac OS X and all LINUX Kernels since V2.4.20.

For use with any AIS compatible PC navigation software, such as the latest SmarterTrack, MaxSea, SeaPro, Nobeltec and Rose-Point applications.

* NOTE – similar to hand-held VHF’s, which have a reduced range compared to fixed mount VHF’s (no antenna ground plane), the uAIS does not have the same range as the AIS100/200 black box AIS units. If maximum AIS range is your highest priority then one of the other Digital Yacht receivers should be used, but for small boats with the aerial mounted at deck level, 10 miles is a good range for AIS and the uAIS is recommended.

SPECIFICATIONS

- USB powered AIS smart antenna
- Simple to install “all in one” smart antenna solution
- Integral 1” x 14 TPI thread for fixing to standard VHF mounts
- 5m USB cable
- High performance dual channel AIS receiver for use with existing plotter and radar systems
- High speed NMEA output (38,400 baud)

EXTRA APPLICATIONS

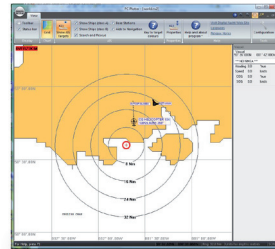

All Digital Yacht systems ship with SmarterTrack Lite PC software

DIMENSIONS

180mm x 100mm
(H x W)

PART NUMBER

ZDIGuAIS
UPC
030955183633

SUPPLIED WITH

5m USB cable and User Manual.
AIS Lite included

PRICE

\$ 349.95



AIS



USB



WINDOWS 8



LINUX



MAC

AIT1500 CLASS B AIS TRANSPONDER

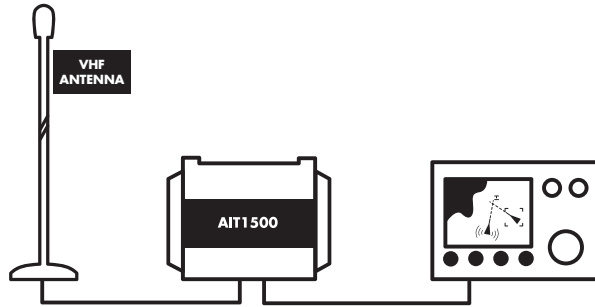

Typical system

“An easy to install Class B AIS with built in GPS antenna and universal NMEA 0183 interface”

KEY FEATURES

The regulations for AIS demand that the Class B transponder has to incorporate its own GPS positioning receiver which normally involves fitting an external antenna. The AIT1500 incorporates a high sensitivity GPS antenna within its compact case which saves on antenna clutter and makes for a speedy installation. It's ideal for fitting on smaller vessels and tenders. It uses a NMEA0183 interface for simple connection to the vast majority of AIS compatible chart plotters and also has a separate 4800 baud GPS data output for the DSC VHF if required. It consumes less than 2W power and can operate on 12/24V systems. It also features a silence capability so the AIS transmissions can be muted while continuing to receive AIS traffic.

There is a USB interface for programming as well as for PC/MAC based navigation. It's compatible with Digital Yacht's NavLink MAC app and SmarterTrack PC navigation system

GPS signals will pass through plastic, glass and GRP so it will be able to be mounted below decks on many boats. A dedicated VHF antenna is required for the AIS or a suitable VHF-AIS antenna splitter such as the SPL2000. It can also connect to the WLN10

or AquaWear WLN20 wireless data gateway to feed data to a tablet or iPad

SPECIFICATIONS

- Advanced AIS design for the best performance
- Waterproof compact enclosure
- Built in internal GPS antenna
- Dual NMEA 0183 outputs at 4800/38400 baud
- USB interface
- PC & MAC programming software included
- NMEA input multiplex function
- Silence switch option
- Supplied with programming and utilities CD

DIMENSIONS

120 x 160mm
(H x W)

PART NUMBER











ZDIGAIT1500
UPC
081159830366

SUPPLIED WITH

0.75M power and data cable, 0.75m
USB cable and programming/
utilities CD

PRICE

\$ 649.95

									
TRANSMITTER	AIS	USB	INTERFACE	MULTIPLIER	GPS	WINDOWS 8	LINUX	MAC	ANDROID

AIT2000 TRANSPONDER (CLASS B)

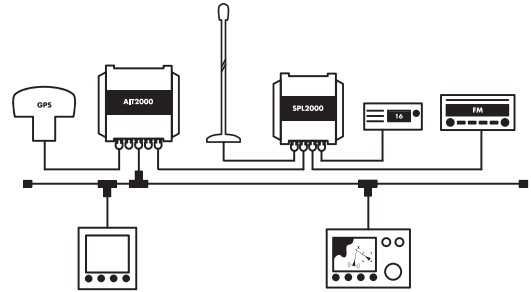

Typical system

“Great value, flexible AIS transponder solution with multiple outputs to suit every installation and optional wireless solution”

KEY FEATURES

The AIT2000 uses the latest AIS Transponder technology to squeeze more performance and interfacing options in to a housing that is half the size of our previous generation transponder.

This ultra-compact Class B Transponder has three outputs; NMEA 0183, NMEA 2000 and USB connection, allowing it to work with every AIS compatible chart plotter or software package on the market today. Featuring a remote silence button option, two NMEA 0183 Inputs and Outputs, four status LEDs and rugged vibration-proof mounting brackets, the AIT2000 is the third generation of Digital Yacht AIS transponder and replaces the very popular AIT1000.

Configuration of your vessel's fixed data, such as MMSI, call sign, boat name, dimensions etc. is made easy with the included Windows and Mac compatible proAIS2 software. Once configured, the unit will provide AIS data to a PC or Mac running suitable navigation software or a dedicated chart plotter, such as the latest Garmin, Raymarine, Navico, Standard Horizon and Furuno units.

As well as transmitting your own vessel's position so that other AIS equipped vessels know where you are, the AIT2000, when connected to an existing VHF antenna (via a splitter) or dedicated

AIS antenna, will receive all AIS targets within range of your boat – typically up to 30NM

With two industry standard NMEA 0183 outputs, our own N2NET connector for plugging in to an NMEA 2000 network and a simple plug and play USB connection to a PC, the AIT2000 is the perfect AIS transponder solution for all light marine vessels up to 300 tonnes.

SPECIFICATIONS

- Latest generation AIS technology – featuring a brand new AIS transponder (Class B) design
- Ideal for use with existing plotter and radar systems
- Built-in high performance 50 channel GPS receiver (ideal also as a backup GPS)
- USB Interface for simple plug and play connection to a PC or Mac
- Includes N2Net interface and cable for connection to NMEA 2000 network
- High speed NMEA output (38,400 baud) – compatible with industry standard plotters
- Comes complete with GPS antenna with integral 1”x14TPI thread mount
- Requires VHF antenna or dedicated AIS antenna (available as optional accessory) or splitter (SPL2000)
- Remote Silence Switch option
- Supplied with programming software for user programming*
- Easy to install black box solution

**Except US where dealer programming required*

DIMENSIONS

150mm x 155mm x 37.5mm
(L x W x D)

PART NUMBER

ZDIGAIT2000

UPC

030955183626

SUPPLIED WITH

0.75m Power/Data cable, 0.75m USB cable, 0.75m N2Net cable, GPS Antenna

PRICE

\$ 729.95



AIT3000 NUCLEUS CLASS B AIS TRANSPONDER

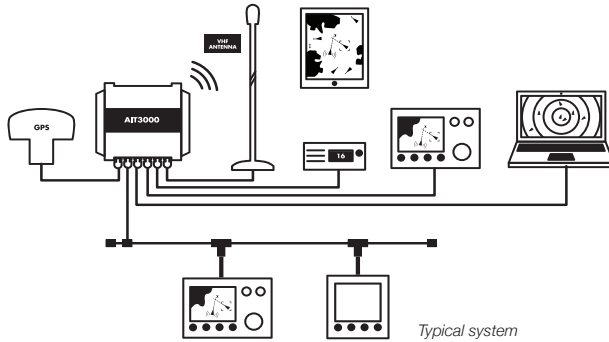

“The AIT3000 integrates a Class B AIS transponder with a ZeroLoss VHF-AIS splitter and full featured interface including NMEA0183, NMEA2000, USB and wireless making it easy and fast to install as well as offering maximum connectivity.”

KEY FEATURES

Class B AIS transponders have made a remarkable impact on small craft navigation but many potential users or installers are put off by the requirement for yet another VHF antenna. The AIT3000 “Nucleus” Class B transponder changes this.

It incorporates not only a full function Class B AIS transponder but also an antenna splitter allowing the main VHF antenna on the boat to be shared with the AIS and VHF. It’s also been designed with the latest interfacing capability including NMEA 0183, NMEA 2000, USB and a WiFi server to integrate with tablets and iPads – hence the name Nucleus as it becomes the hub for on board navigation. NMEA 0183 data from other on board systems can also be multiplexed by the Nucleus and combined on the WiFi link. Nucleus brings a new level of connectivity and integration.

Today’s boat is all about connectivity - the Nucleus offers not only NMEA interfacing but USB for PC and MAC and WiFi for tablets and smartphones.

Digital Yacht has iAIS and NavLink apps for iOS and AISView for Android.

SPECIFICATIONS

- Combination Class B AIS transponder with patented ZeroLoss VHF-AIS antenna splitter
- Full connectivity via
 - NMEA0183 Dual In/Out Interfaces
 - Built in multiplexer for instrument data
 - NMEA 2000 output
 - USB (PC and MAC)
 - Inbuilt WiFi server for tablets & smartphones
- Remote silence switch capability
- Ultra tough, waterproof and compact construction
- FM antenna output
- Supplied with GPS antenna
- Supported range of apps for iOS, Android, PC & MAC

SUPPLIED WITH

- | | |
|----------------------------------|---------------------------------|
| MA800 GPS antenna | SmarterTrack Lite and proAIS2 |
| 3dBi WiFi antenna | iAIS - Free download from Apple |
| 0.8m NMEA 2000 drop cable (male) | app store |
| 0.8m NMEA 0183 power-data cable | Mounting brackets |
| 0.8m USB cable | PL259 patch cable for VHF |
| Driver and software CD with | |

DIMENSIONS

220mm x 130mm

PART NUMBER

ZDIGAIT3000

PRICE

\$ 1395.95

UPC

081159830304



GV30 AIS VHF GPS ANTENNA

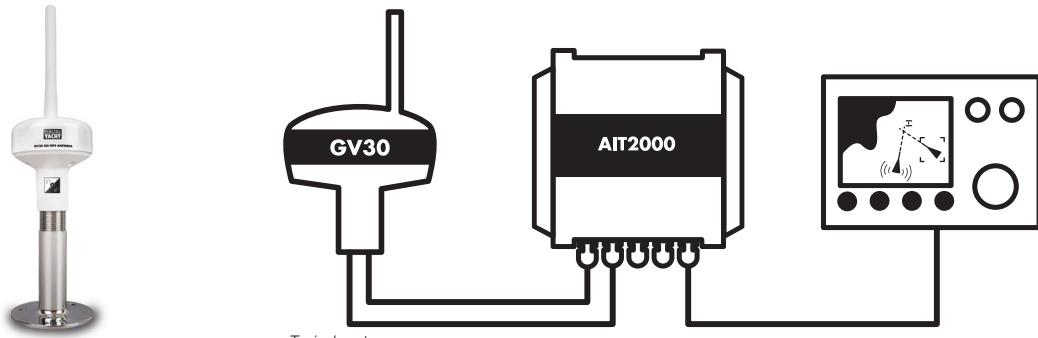

Typical system

“Combination AIS/VHF and GPS antenna for Class B transponders which makes for a super quick and high performance installation”

KEY FEATURES

A Class B AIS transponder requires a dedicated GPS antenna (all Class B units must have their own internal GPS and can't use an external feed for regulatory purposes) as well as a VHF antenna or suitable VHF-AIS antenna splitter. The GV30 is a combination VHF/AIS and GPS antenna with twin coax feeds (10m). It's fitted with a standard 1" threaded base so will mount onto a variety of deck, pole and rail attachments available from many 3rd party suppliers.

The 10m coax cables are terminated with a FME mini connector which makes running the cable easy as the connector is barely bigger than the 5mm cable. We then supply suitable adaptors for the TNC and BNC connectors on our AIT2000.

The GV30 is just 190mm high and 75mm in diameter. Despite its compact dimensions, it offers very good performance as its specifically tuned to 162MHz (AIS frequency). The GV30 is also available with the AIT2000 as a bundle

SPECIFICATIONS

- Combination AIS/VHF and GPS antenna
- Specifically tuned to 162MHz
- High gain GPS element
- Supplied with 2 x 10m cable tails fitted with mini connectors for easy cable installation
- Standard 1" threaded base for compatibility with a variety of 3rd party mounts
- Supplied with TNC (GPS) and BNC (AIS) adaptors
- Under 200mm high for low profile installation

DIMENSIONS

75MM X 190MM
(L x H)

PART NUMBER

ZDIGGV30
UPC
081159830076

SUPPLIED WITH

Supplied with user manual, 10m cables, TNC adaptor and BNC adaptor

PRICE

\$ 160.00

Note: not supplied with base



AIS



RADIO



GPS

SPL2000 VHF-AIS ANTENNA SPLITTER

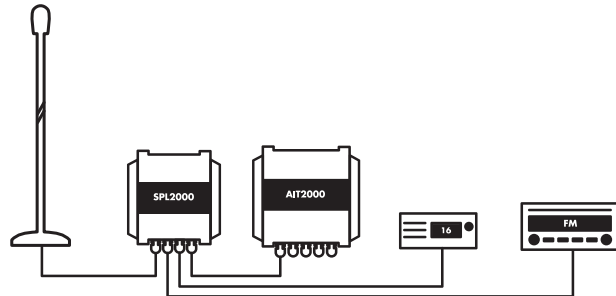

Typical system

“Patented zero loss technology lets you share your main VHF antenna with both the VHF and AIS. Compatible with transponders and receivers”

KEY FEATURES

An AIS receiver or transponder requires a VHF antenna, but Digital Yacht’s new SPL2000 AIS-VHF antenna splitter allows an existing antenna to be used for both the AIS and VHF (DSC) and even with an AM/FM radio. Unlike most simple splitters, it can also be used with a class B transponder system and it incorporates special circuitry to ensure safe operation of the two transmitting devices. The unit has four simple connections - one input for the main VHF antenna and then outputs for the AIS receiver/transponder, DSC VHF as well as an optional car radio output. It utilises Digital Yacht’s new, patented, ZeroLoss™ technology, to ensure the very best possible reception and transmission from all devices. Most importantly it is also fail safe, so should the unit ever stop working or lose power, it will not affect the main VHF operation.

Until now, Digital Yacht, have recommended a dedicated antenna for a receiver or transponder. However, with the new this new ZeroLoss™ technology, we can now offer a solution that greatly simplifies installation whilst maintaining performance.

The unit is waterproof and matches the aesthetics of the current range of transponders and receivers, so can easily be integrated into any vessel. It is suitable for operation on 12V or 24V systems and features three status LEDs that show the unit is powered correctly and when the AIS or VHF transmits.

SPECIFICATIONS

- Enables an existing VHF antenna to be used for both the standard VHF and AIS system
- Patented ZeroLoss™ technology for exceptional performance
- Works with all Class B transponders and receivers
- Supplied with power cable, PL259-PL259 cable assembly and BNC-BNC cable assembly for easy installation (all cables 0.75m long)
- AM-FM radio antenna connection for standard car stereo radio (integrated in power cable)
- 12v or 24v Operation and low power consumption
- Fail safe operation
- Same size and design as the new AIT2000
- Makes installation of an AIS receiver or transponder very quick and simple
- Saves on additional antenna clutter

DIMENSIONS

150mm x 155mm x 37.5mm
(L x W x D)

PART NUMBER

ZDIGSPL2000
UPC
030955183756

SUPPLIED WITH

0.75m PL259 and BNC Coax interconnect cables, 0.75m power lead, integral fixing brackets and manual

PRICE

\$ 369.95



AIS



RADIO

AIS LIFE GUARD (AIS MAN OVERBOARD ALARM)

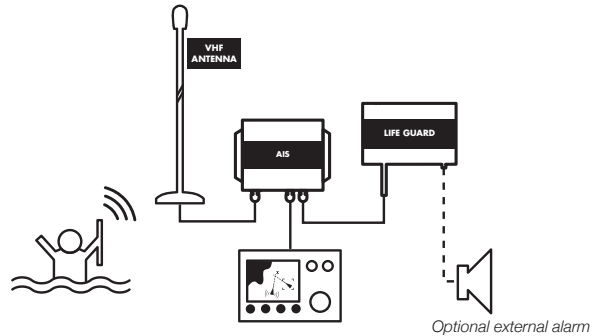

Typical system

“AIS SART Alarm — Connects to any of our AIS devices and detects a SART target — ideal for use as a MOB system with personal SARTs”

KEY FEATURES

The AIS Life Guard is the world’s first AIS Man Overboard Alarm designed to work with the new generation of AIS SARTs that have recently been approved for global use by the IMO. Many existing AIS compatible chart plotters do not fully support AIS SARTs but with the AIS Life Guard connected to an AIS transponder or AIS receiver, you can have a complete working AIS SART man overboard system. Operation is automatic, simply connect the two wire NMEA input on the AIS Life Guard to the NMEA output of your AIS and it will listen to all AIS traffic.

As soon as an AIS SART transmission is detected the AIS Life Guard will sound its internal 95dB alarm and display a red warning light. For larger installations, it can also be connected to an external alarm (not supplied) so that the whole boat is immediately alerted.

The AIS Life Guard detects both message 1 and message 14, the two AIS messages reserved for AIS SARTs and will also give a short three beep alarm if it detects an AIS SART test message, great for checking correct operation of your AIS SARTs prior to a voyage.

All Digital Yacht AIS receivers and transponders are compatible with the AIS Life Guard and it is designed to operate on 12v or 24v DC systems.

SPECIFICATIONS

- World’s first dedicated AIS Man Overboard Alarm system
- Listens to AIS data on NMEA0183 Input
- Alarms when AIS SART message 1 and 14 are detected
- Internal 95dB buzzer with option to drive external alarm (not supplied)
- Audible and Visual Alarms
- Push button to silence alarm (short press) and reset alarm (long press)
- Easy to install IP54 black box solution

DIMENSIONS

150mm x 155mm x 37.5mm
(L x W x D)

PART NUMBER

ZDIGAISLG
UPC
30955183718

SUPPLIED WITH

0.75m Power/Data cable and User Manual

PRICE

\$ 299.95



AIS



SAFETY



INTERFACE

AIS SYSTEMS SPECIFICATIONS



	AIS100	AIS100 USB	AIS100 PRO	AIS200 N2NET	ANT200	uAIS	iAIS	AISNET
KEY FEATURES	Value priced AIS receiver with NMEA 0183 38400 baud industry standard output	Value priced AIS receiver with USB PC/MAC connection. Requires separate DC power	AIS Receiver with dual USB and NMEA (38400 baud) output. NMEA Input with multiplex capability too	Offers AIS functionality plus NMEA 0183 multiplex facility, N2K output and PC USB connection	Self contained AIS "Smart" antenna with NMEA 0183 38400 baud output and NMEA input multiplex capability	Self contained AIS "Smart" antenna with USB connection for power and data. Ideal for use on PC navigation systems	Combination AIS receiver and NMEA multiplexer for iPhone/ Pad products with wifi and traditional data outputs	Shore side network receiver for use as AIS feed to internet tracking sites and other network applications
DUAL CHANNEL RECEIVER	●	●	●	●	●	●	●	●
RECEIVER FREQUENCY	161.975 MHz 162.025 MHz	161.975 MHz 162.025 MHz	161.975 MHz 162.025 MHz	161.975 MHz 162.025 MHz	161.975 MHz 162.025 MHz	161.975 MHz 162.025 MHz	161.975 MHz 162.025 MHz	161.975 MHz 162.025 MHz
RECEIVER SENSITIVITY	<-107dBm at 20% PER	<-107dBm at 20% PER	<-107dBm at 20% PER	<-107dBm at 20% PER	<-107dBm at 20% PER	<-107dBm at 20% PER	<-107dBm at 20% PER	<-107dBm at 20% PER
NMEA 0183 38400 BAUD OUTPUT	●		●	Two	●		●	
USB PC CONNECTION		●	●	●		●	●	●
N2NET/NMEA 2000 OUTPUT				●				
ETHERNET OUTPUT VIA RJ45								●
WIFI OUTPUT	Optional with WLN10HS		Optional with WLN10HS	Optional with WLN10HS	Optional with WLN10HS		●	
WIFI RANGE TYP							30-100m max	
N° OF WIFI USERS							Five	
NMEA INPUT MULTIPLEX			●	Two	●		●	
PC SOFTWARE	●	●	●	●	●	●	●	●
POWER REQUIREMENT	12/24V	12/24V	12/24V	12/24V	12/24V	USB from PC/ MAC	12/24V	12/24V DC. AC 110/220 V ADAPTOR SUPPLIED
POWER DRAW (TYPICAL MAX 12V)	90mA	90mA	90mA	80mA	90mA	90mA	250mA	250mA
VHF ANTENNA REQUIRED *	●	●	●	●			●	●
PROTECTION	IPX4	IPX4	IPX4	IPX5	IPX7	IPX7	IPX5	IPX0
ANTENNA CONNECTION	BNC (F)	BNC (F)	BNC (F)	BNC (F)	N/A	N/A	BNC (F)	BNC (F)
DIMENSIONS	75x105x32mm (HxWxD)	75x105x32mm (HxWxD)	75x105x32mm (HxWxD)	152x 152x 152mm (HxWxD)	180x100mm (HxDia)	180x100mm (HxDia)	150x150x 38mm (HxWxD)	150x244x 61mm (HxWxD)

* or compatible AIS VHF splitter

HSC100 COMPASS SENSOR

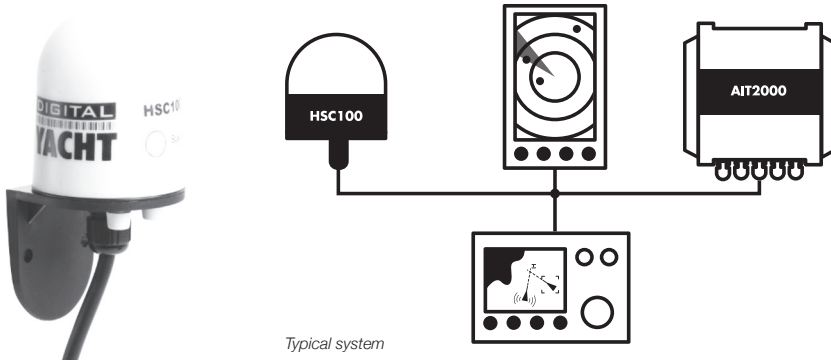

Typical system

The HSC100 will provide a 10Hz fast heading output for AIS, MARPA, radar course up/north up and chart plotter applications

“Fluxgate compass with auto calibration and fast heading output for MARPA or course up radar stabilisation”

KEY FEATURES

Accurate compass heading data remains a fundamental parameter for marine navigation and the HSC100 uses fluxgate technology to deliver heading data for on board systems. Typical applications include enabling course up and true motion type displays on chart plotters, radar overlay onto electronic charts and stabilisation of radars when used for MARPA/ARPA target tracking. Integrated instrument systems can also benefit from having compass information to calculate real time tidal set and drift when interfaced with a log and GPS.

Most low cost heading sensors only output data at 1Hz (once per second) but the HSC100 outputs at 10Hz which is required for MARPA target tracking and accurate radar overlays (Part # ZDIGHSC100).

We have also released a new “Rate of Turn” version of the HSC100 that outputs the HDT and ROT messages required by a Class A transponder. For non-mandatory vessels, this provides a simple low cost solution for adding heading and rate of turn to Class A transponders (Part # ZDIGHSC100T)

The HSC100 is waterproof (to IPx7) so can be mounted externally on steel hulled vessels. It also features an automatic calibration routine to compensate for the effects of nearby magnetic influences. This involves turning the boat through 1.5 circles at a constant angular velocity whilst in calibration mode. Once completed, typical accuracies are within 0.5 degrees.

SPECIFICATIONS

- High Speed (10HZ) NMEA electronic fluxgate compass sensor
- Ideal for use with radar overlay and MARPA target tracking systems
- Industry standard NMEA 0183 “HDG” output
- Gimballed to 45°
- New “Rate of Turn” version of the HSC100 now released for Class A transponders (HSC100T)
- 12/24v DC operation with minimal power consumption
- Waterproof to IPx7 and suitable for external mounting on a steel hulled vessels
- Automatic calibration routine and manual compass offset feature
- Additional AD10 heading output for interface to Furuno systems
- LED Status Indicator
- 15m interconnect cable

DIMENSIONS

68mm x 30mm
(W x H)

PART NUMBER

ZDIGHSC100
ZDIGHSC100T

UPC

030955183688
030955183763

SUPPLIED WITH

15m Cable and manual

PRICE

\$ 369.95



COMPASS



INTERFACE

GPS150 DUALNAV™ GPS/GLONASS SENSOR

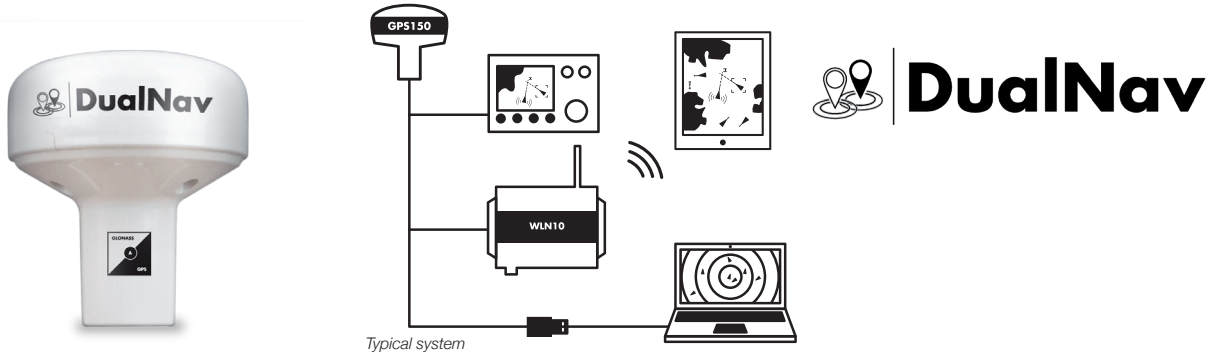

“DualNav technology offers unprecedented positioning accuracy with GPS and GLONASS compatibility and 10Hz super-fast NMEA position updates”

KEY FEATURES

The GPS150 DualNav™ positioning sensor combines a super accurate 50 channel GPS with GLONASS, the Russian funded satellite positioning system that is now on line and providing an excellent back up or alternative to GPS. This “smart” sensor will automatically switch between the systems or the user can manually select the most appropriate for their activity. In DualNav mode, a sophisticated algorithm combines GPS and GLONASS data to offer sub 1m accuracy. The GPS150 will also be able to utilise the European funded Galileo positioning system when it comes on line (IOC – Initial Operation Capability in 2018).

The implementation of GLONASS as an additional satellite positioning system is probably the biggest step change in maritime navigation since GPS was fully augmented back in the mid 90’s. Digital Yacht’s GPS150 utilises the industry standard NMEA data format allowing older chart plotters as well as current generation products to take advantage of this new technology.

The GPS150 also allows the user to select a variety of different NMEA baud rates (4800, 38400 and 115200) to allow interfacing with legacy and current systems. It also supports a new TurboNav™ mode which will appeal to racing yachtsmen and performance users where GPS/GLONASS data is output at 10Hz (10 x faster update than normal) and with an interface speed of 115200 baud which is 24 x the speed of normal NMEA data. This massively improves slow speed navigation data as well as providing the best course and speed data in a dynamic situation.

The GPS150 houses all the electronics in its compact 75mm antenna and has a single multi core cable for power and data.

Power consumption is just 30mA at 12V. It can be used as a simple positioning sensor for plotter or VHF DSC systems as well as a precision, high speed sensor for performance sailing/super yachts. Setup is easy with a block of simple internal switches setting the characteristics of the unit. This allows the device to be programmed in the field without specialist software or programming tools.

The GPS150 can also connect to the VLN10 wireless interface to allow data to be sent to mobile devices such as iPhones, iPads and Tablets. There is also a USB interface for PC and MAC users (ZDIGUSBNMEA).

SPECIFICATIONS

- 50 channel precision GPS/GLONASS positioning sensor
- Just 75mm in diameter and designed to fit industry standard 1” mounts
- Ultra tough, waterproof construction
- NMEA output configurable for 4800, 38400 and 115200 baud
- Selectable update rates from 1 to 10Hz
- Configurable in the field using simple DIP switches inside the antenna
- TurboNav mode offers super fast updates to optimise positioning information in slow and high speed applications
- WAAS/EGNOS/SBAS enabled for sub 1m accuracy
- User selectable GPS/GLONASS mode or auto selection
- Ultra low 30mA power consumption (at 12V DC)
- 5-30V DC power input

The installer can set the characteristics of the GPS150 such as mode, NMEA data output and update rate using a series of simple internal DIP switches - no complicated software to upload.

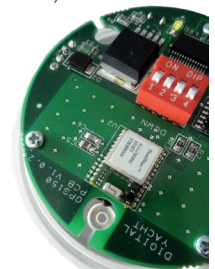



DualNav

GPS AND NOW GLONASS

Knowing your position whilst at sea is key to safe navigation. What we now take for granted, was extremely difficult, time consuming and inaccurate. Then, in the latter half of the 20th century, came the electronic positioning systems – Decca, Loran, Transit and in the 1990s, the global positioning system, GPS. Over 20 years have passed since the first GPS receivers were commercially available and in this time the whole world has come to rely on this US funded technology. Now every boat, plane, car and train that we travel on has GPS navigation and even your smart phone can give a GPS position accurate to within 10m, anywhere in the world, at the touch of a button.

Much political discussion has taken place over our reliance on GPS technology, to the point where both Europe (Galileo) and China (Compass) are developing their own satellite based navigation systems, which are scheduled to be fully operational by 2020. However, whilst GPS was being developed in the 1980s, there was another competitive system developed in Russia called GLONASS. This system was very much overshadowed by the American GPS system and due to the secrecy surrounding the technology and the difficulties for non-Russian companies to license this technology, it never achieved wide spread commercial use outside of Russia and surrounding countries.

During Russia's difficult financial period between 1989-1999, government spending on their space program was cut by 80% and launching of new GLONASS satellites stopped. With relatively short life spans the GLONASS satellites soon started to fail and by 2001 there were only 6 satellites still operational and the GLONASS service effectively ceased.

Most observers at the time thought this would be the death of GLONASS but in 2000, with the Russian economy recovering, President Vladimir Putin took a special interest in GLONASS and made the restoration of this service a high priority. Between 2002-2011, a large investment was made and at the end of 2011 GLONASS was fully restored and now offers worldwide coverage (with 24 operational satellites) and accuracy almost as good as GPS. In areas of

high Latitudes (North and South) GLONASS is more accurate than GPS due to the orbital position of the satellites.

DUALNAV™ – NEW TECHNOLOGY

Now with the GPS150 DualNav™ technology, boat owners can have a single sensor that will automatically read satellite data from both GPS and GLONASS constellations, choosing the best signals from over 50 satellites. Wherever you are in the world you now have twice the satellites to choose from resulting in the GPS150 receiver having much better coverage, time to first fix and positional accuracy. Add to this the new high sensitivity receiver design, selectable baud rate and 10Hz position update rate and you have a GPS receiver that is significantly better than every previous marine GPS receiver on the market.

The new performance is particularly noticeable if the receiver is mounted below deck/inside the wheelhouse where the high sensitivity receiver still gives a good position fix or when there are obstructions blocking the view of the sky, such as a wet sail shadowing the antenna or when sailing in rivers or close to cliffs, plus DualNav™ technology with more satellites to choose from, gives a much more accurate fix.

On larger boats, it is now possible to have two completely separate position sources, not just two GPS units but two different positioning systems so that you can compare and validate your actual position. Set one GPS150 to GPS mode and another GPS150 to GLONASS mode and you have dual redundancy and two independent positioning systems.

The GPS150 also supports SBAS (Satellite-Based Augmentation System) which is the generic name given to the differential signal transmitted by various local geo-stationary satellites. SBAS allows the GPS150 receiver to remove errors in the position due to environmental conditions and improves accuracy down to <1m. Using WAAS in the US and EGNOS in Europe the GPS150 will automatically switch to differential SBAS mode when available.

DIMENSIONS

75mm
(D)

PART NUMBER

ZDIGGPS150
UPC
081159830014

SUPPLIED WITH

Supplied with User manual and a
10m cable

PRICE

\$ 189.95



INTERFACE



GPS



GLONASS



AUTO GNSS



MANUAL GNSS



10Hz UPDATE



TURBONAV

GPS150USB DUALNAV™ GPS/GLONASS SENSOR

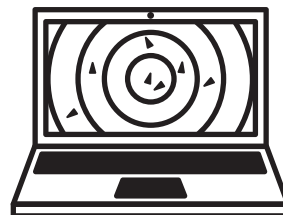
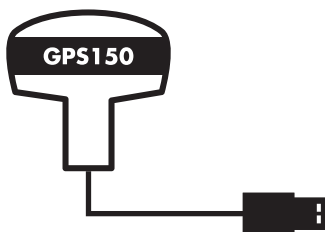

Typical system

“DualNav technology offers unprecedented positioning accuracy with GPS and GLONASS from this USB smart antenna”

KEY FEATURES

The GPS150USB DualNav™ positioning sensor combines a super accurate 50 channel GPS with GLONASS, the Russian funded satellite positioning system that is now on line and providing an excellent back up or alternative to GPS. This “smart” sensor will automatically switch between the systems or the user can manually select the most appropriate for their activity. In DualNav mode, a sophisticated algorithm combines GPS and GLONASS data to offer sub 1m accuracy. It’s designed to connect to a PC or MAC (an even LINUX system) via a USB connection. It also derives power via the USB cable so it’s completely self contained an ideal for use on charter boats with a notebook PC charting system. The GPS150USB will also be able to utilise the European funded Galileo positioning system when it comes on line (IOC – Initial Operation Capability in 2018). Digital Yacht’s GPS150USB utilises the industry standard NMEA data format and the USB connection creates a virtual COM port on the PC or MAC which is easily usable by all common marine charting programs such as MaxSea, SmarterTrack, SeaPro, Rosepoint, Nobeltec, Maptech, Expedition, Imray etc.

The GPS150USB also allows the user to select a variety of different NMEA baud rates (4800, 38400 and 115200) to allow interfacing

with legacy and current PC systems. It also supports a new TurboNav™ mode which will appeal to racing yachtsmen and performance users where GPS/GLONASS data is output at 10Hz (10 x faster update than normal) and with an interface speed of 115200 baud which is 24 x the speed of normal NMEA data. The GPS150USB houses all the electronics in its compact 75mm antenna and has a single 5m USB cable for power and data. Power consumption is minimal via the USB connection. Setup is easy with a block of simple internal switches setting the characteristics of the unit. This allows the device to be programmed in the field without specialist software or programming tools.

SPECIFICATIONS

- Self-powered via 5m USB cable
- 50 channel precision GPS/GLONASS positioning sensor
- Works with all popular PC/MAC/LINUX charting programs
- Ultra tough, waterproof construction
- NMEA output (via USB) configurable for 4800, 38400 and 115200 baud
- Selectable update rates from 1 to 10Hz
- Configurable in the field using simple DIP switches inside the antenna
- TurboNav mode offers super fast updates to optimise positioning information in slow and high speed applications
- WAAS/EGNOS/SBAS enabled for sub 1m accuracy
- User selectable GPS/GLONASS mode or auto selection

DIMENSIONS

75mm
(D)

PART NUMBER

ZDIGGPS150USB
UPC
081159830113

SUPPLIED WITH

Supplied with user manual, 5m cable and CD

PRICE

\$ 269.95



GPS



GLONASS



AUTO GNSS



MANUAL GNSS



10Hz UPDATE



TURBONAV



USB

NMEA TO WIFI SERVER

WLN10 WIRELESS NMEA SERVER (4800 BAUD)

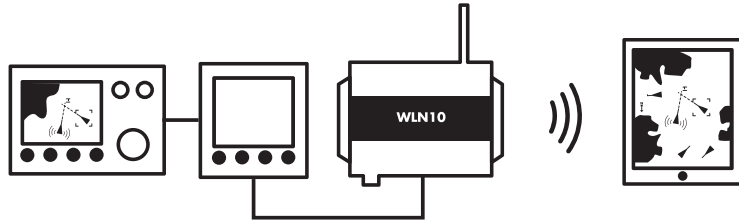

Typical system

“Create a wifi network on your boat with NMEA data available for iPhones, iPad or Android tablets — and PCs and MACS too. Turn you mobile device into a full featured navigator with access to all your boat’s NMEA data”

KEY FEATURES

This innovative and cost effective wireless device creates its own 802.11b+g wireless access point which any other wireless device can connect to, such as a Smart Phone, Netbook or Laptop. Connect it to any device or system that has an NMEA 0183 output and it will automatically read the data and transmit it wirelessly to another wireless device. The NMEA 0183 data is transferred using TCP/UDP protocol to a suitably compatible application on the wireless device.

A number of Marine Navigation software packages support TCP/UDP data transfer including;

- SmarterTrack (PC)
- SeaPro (PC)
- Rose Point Coastal Explorer (PC)
- MaxSea (PC) and Nobeltec (PC)
- MacENC (Macs)
- iNavX (iPhone/iPad)
- Nav Apps: iSailor and iRegatta

SPECIFICATIONS

- Wireless NMEA Data server (4800 baud)
- Reads NMEA 0183 data and transmits it wirelessly over 802.11b+g
- Can be fitted to any GPS or Instrument system that is outputting/inputting NMEA 0183 data at 4800 baud
- Supports Bi-Directional communication but must be at the same 4800 baud rate
- Creates an 802.11b+g wireless access point and then transmits data via TCP/UDP link
- TCP allows single device connection while UDP allows multiple devices to receive the data
- Fully compatible with popular iNavX navigation application for Apple mobile devices
- Easy to install IP54 black box solution

EXTRA APPLICATIONS

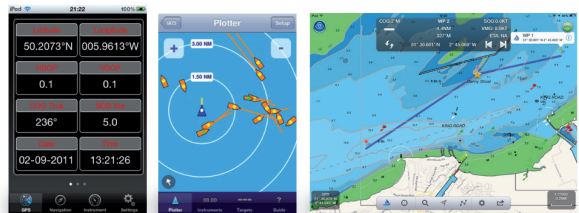

Visit the App Store to see the range.

DIMENSIONS

105mm x 72mm x 32mm
(L x W x D)

PART NUMBER

ZDIGWLN10
UPC
738435472580

SUPPLIED WITH

1m Power/Data cable, Wifi Antenna
and User Manual

PRICE

\$ 299.95



WIRELESS



INTERFACE

NMEA TO WIFI SERVER

WLN10HS WIRELESS NMEA SERVER (38400 BAUD)

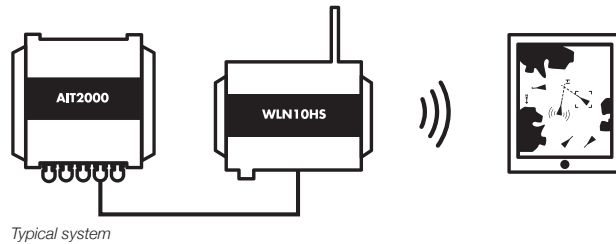

“Create a wifi network on your boat with NMEA data available for iPhones, iPad or Android tablets — and PCs and MACS too. Turn you mobile device into a full featured navigator with access to all your boat’s AIS data — the WLN10HS is preset to 38400 baud for AIS information”

KEY FEATURES

This innovative and cost effective wireless device creates its own 802.11b+g wireless access point which any other wireless device can connect to, such as a Smart Phone, Netbook or Laptop. Connect it to any device or system that has an NMEA 0183 output and it will automatically read the data and transmit it wirelessly to another wireless device. The NMEA 0183 data is transferred using TCP/UDP protocol to a suitably compatible application on the wireless device.

A number of Marine Navigation software packages support TCP/UDP data transfer including;

- SmarterTrack (PC)
- SeaPro (PC)
- Rose Point Coastal Explorer (PC)
- MaxSea (PC) and Nobeltec (PC)
- MacENC (Macs)
- iNavX (iPhone/iPad)
- Nav Apps: iSailor and iRegatta

If you are connecting the WLN10HS to an AIS receiver or transponder, then Digital Yacht’s free iAIS app is downloadable from the Apple App Store, which will display an AIS radar type picture on your Apple device.

SPECIFICATIONS

- High Speed Wireless NMEA Data server
- (38400 baud)
- Reads NMEA 0183 data and transmits it wirelessly over 802.11b+g
- Can be fitted to an AIS unit or NMEA Multiplexer that is outputting/inputting NMEA 0183 data at 38400 baud
- Supports Bi-Directional communication but must be at the same 38400 baud rate
- Free iAIS App for iPhone, iTouch or iPad
- Creates an 802.11b+g wireless access point and then transmits data via TCP/UDP link
- TCP allows single device connection while UDP allows multiple devices to receive the data
- Fully compatible with popular iNavX navigation application for Apple mobile devices
- Easy to install IP54 black box solution

DIMENSIONS

105mm x 72mm x 32mm
(L x W x D)

PART NUMBER

ZDIGWLN10HS
UPC
738435472610

SUPPLIED WITH

1m Power/Data cable, Wifi Antenna
and User Manual

PRICE

\$ 299.95



WIRELESS



INTERFACE

AQUAWEAR WLN20 WIRELESS GATEWAY WITH WRIST CASE

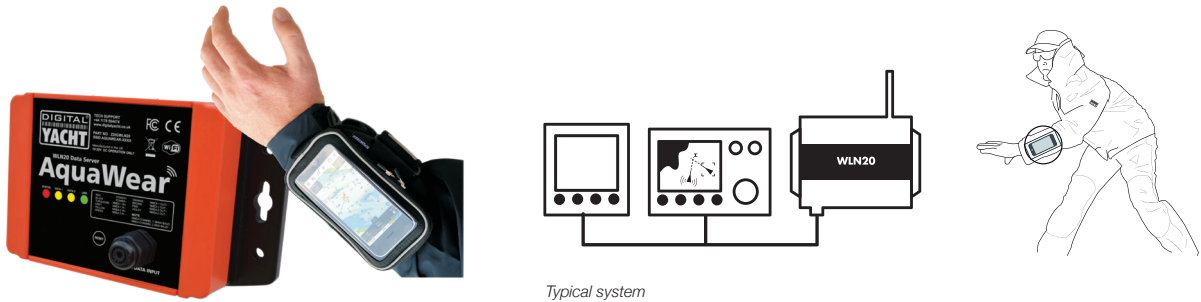

Typical system

“A wireless data gateway to connect smart phones and tablets system and introduces wearable navigation to the marine market with its stylish wrist case”

KEY FEATURES

The WLN20 is a wireless NMEA data server with two channel input. Stream real time NMEA information from your instrument, GPS and AIS systems to iPhones, smartphones, tablets and PCs. It ships with an AquaWear wrist case enabling next generation wearable navigation. Pop your smartphone into the supplied wrist case and start wearing your nav data on your sleeve. You'll benefit from using your accurate boat data and improve battery life on your smartphone as you'll not be reliant on its GPS and it will work below decks.

It's intuitive, easy and moves with you and of course allows you to choose from 1000's apps to suit your app! Digital Yacht have a range of compatible apps including NavLink and iAIS for iOS and AISView for Android. What's more it's interfaced using open NMEA 0183 standards so will work with any popular marine electronics system. Even legacy systems can connect bringing the latest apps to older systems.

It supports multiple devices and operating systems allowing all your crew to be connected. You can even stream data to a tablet,

iPad or PC/MAC below decks. No connection to the internet is required as the WLN20 creates a local wifi hotspot on board your boat. Simply search for the AquaWear wifi network on your device and connect and allow streaming boat NMEA data to be utilised by your device. The wireless network will typically footprint a GRP boat up to 25m in length. For large wooden and steel vessels please contact us and we can advise on installation techniques to ensure adequate coverage

SPECIFICATIONS

- Wireless data server for NMEA based systems
- Dual 4800/38400 baud NMEA 0183 inputs
- NMEA output from bi directional wireless interface supports more app features
- Compatible with 1000s apps
- AquaWear Alliance SDK available for new app developers
- Compatible with UDP and TCP/IP
- Support for up to 7 connected devices (UDP)
- Waterproof, compact and tough
- Ships with AquaWear wrist case – also available as an accessory
- 12/24v low power operation
- Compatible with 1000s apps for iOS, Android, MAC and PC

DIMENSIONS

160 x 90mm
(L x W)

PART NUMBER

ZDIGNTN10
UPC
081159830311

SUPPLIED WITH

Wrist case for 4-5" phones and
0.75m power/data cable

PRICE

\$ 349.95



WIRELESS



INTERFACE



WEARABLE



MULTIPLEXER

NAVLINK WIRELESS NMEA2000 SERVER

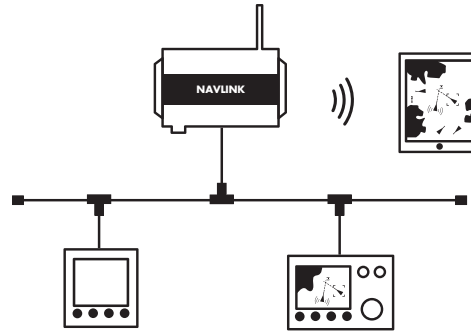

Typical system

“Get data from your NMEA2000 network to a iPad, iPhone or other tablet with the Navlink NMEA2000 wireless server”

KEY FEATURES

With more and more equipment now using NMEA 2000 networking, being able to easily connect the network data to mobile devices such as smart phones, tablets and laptops is becoming an important consideration.

The WLN2Net is a simple and cost effective wireless device that converts NMEA2000 data into a wireless data feed that can be received by any mobile wireless device. Using standard NMEA data formats, the WLN2Net is compatible with all software applications that support TCP (single device) or UDP (multiple devices) data transfer.

A number of Marine Navigation software packages support TCP/UDP data transfer including;

- SmarterTrack (PC)
- SeaPro (PC)
- Rose Point Coastal Explorer (PC)
- MaxSea (PC) and Nobeltec (PC)
- MacENC (Macs)
- iNavX (iPhone/iPad)
- Nav Apps: iSailor and iRegatta

KEY FEATURES

- NMEA 2000 Certified Wireless Data server
- Reads NMEA 2000 data and transmits it wirelessly over 802.11b+g
- Can be fitted to any NMEA 2000 network with integral cable (male micro connector)
- Supports Bi-Directional communication for driving an Autopilot
- Uses standard NMEA data for maximum compatibility with software applications
- Creates a wireless access point and then transmits data via TCP/UDP link
- TCP allows single device connection while UDP allows multiple devices to receive the data
- Single plug 'n play connection to the NMEA2000 network, provides power and data
- Optional USB connection (ZPIEWLN2NETPL) available for providing NMEA2000 data to the boat's nav computer
- Fully compatible with popular iNavX navigation application for Apple mobile devices
- Easy to install IP54 black box solution

DIMENSIONS

105mm x 72mm x 32mm
(L x W x D)

PART NUMBER

ZDIGWLN2NET
ZDIGWLN2NETPL

UPC

030955183817
030955183848

PRICE

\$ 549.95
\$ 599.95

SUPPLIED WITH

1m Power/Data cable, Wifi Antenna
User Manual and CD



WIRELESS



INTERFACE



INTERFACE



USB

NMEA TO NETWORK SERVER

NTN10 NMEA 0183 TO NETWORK GATEWAY

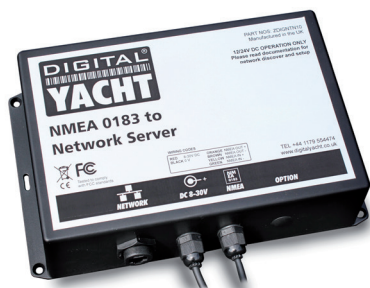

“Overlay NMEA navigation data onto an existing network”

KEY FEATURES

Many large yachts now have an ethernet network installed at the build stage to allow easy installation of modern IT & communications products. The NTN10 allows NMEA 0183 navigation data to also be connected to the network, sharing the same cabling and allowing devices connected to the network to utilise this data.

On larger vessels, there will often be multiple wireless access points connected to the network and these can then also wirelessly transfer the data to connected devices like iPads and tablets.

The main reason for installing is to get navigation data from the vessels instruments, AIS or GPS onto the main network. It means connected devices like iPads or tablets then only have one network to select which can aggregate internet and navigation network data. Skippers can then use their iPad for navigation tasks using the main boat's data. It also introduces the capability of an internet connected app for functionality such as live chart updates or weather overlays.

The NTN10 supports both TCP/IP and UDP data formats for maximum compatibility and can accept 4800 or 38400 baud NMEA data.

SPECIFICATIONS

- NMEA to network server
- Configurable for 4800 or 38400 format NMEA data and also compatible with MUX100 multiplexer
- UDP or TCP/IP server formats programmable by installer
- Simple RJ45 network connection
- Bi directional interface
- 12/24V installation

DIMENSIONS

150 x 244mm
(H x W)

PART NUMBER

ZDIGNTN10
UPC
081159830359

SUPPLIED WITH

0.75m NMEA cable, 1m RJ45
network cable

PRICE

\$ 350.00



INTERFACE



NETWORK

MUX100 NMEA MULTIPLEXER

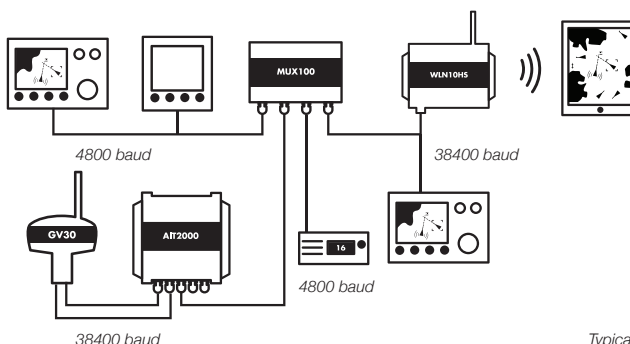

Typical system

“The MUX100 multiplexer combines two channels of NMEA 0183 data and makes NMEA 0183 system integration and interfacing easy.”

KEY FEATURES

With modern AIS receivers and transponders outputting high speed NMEA0183 data at 38400 baud, it is often difficult to connect AIS data and low speed GPS or instrument data at 4800 baud to some chart plotters and/or PCs that have just one NMEA 0183 input. With the MUX100, all data received on the two input ports is multiplexed and transmitted on output 1 at 38400 baud. It is pre-configured so that Input 1 accepts AIS data at 38400 baud and input 2 accepts GPS/instrument data at 4800 baud.

Often low speed GPS data is required to give position information to a DSC VHF, but when an AIS transponder is fitted the GPS data is often only available at 38400 baud which will be ignored by the VHF. The MUX100 intelligently takes the GPS data from the AIS present on input 1 and re-transmits this on output 2 at 4800 baud – which can then be connected to the VHF. As a safety feature, should GPS data on input 1 be invalid or lost, the MUX100 will automatically switch to the GPS data on input 2 and transmit this on output 1 and output 2. To avoid duplicated data confusing other equipment, the MUX100 automatically blocks duplicated data on port 2.

Using intelligent priority switching, the MUX100 gives priority to input 1 but if GPS data is invalid or lost on input 1, it will automatically switch to input 2. When valid position data is received again on input 1, it will automatically revert.

Two LEDs on the face of the unit give indication of the data status, with a solid LED showing which port is currently providing GPS position and a flashing light on the other port to show that data is being received. If either LED is not lit or flashing it indicates no NMEA data present.

SPECIFICATIONS

- Dual input/output NMEA0183 multiplexer – simplifies NMEA integration and installation
- Accepts 38400 baud data on input 1 and 4800 baud data on input 2
- Combines all received data and transmits this data on output 1 at 38400 baud
- Extracts the GPS data from the high speed input 1 and re-transmits at low speed on output 2
- Important safety feature - gives priority to GPS on input 1 but switches to input 2 if position lost on input 1. Will switch back to input 1 when valid position fix data is received again
- Easy to install IP54 black box solution
- Opto isolated inputs and true NMEA differential output capable of driving several devices

DIMENSIONS

105mm x 72mm x 32mm
(L x W x D)

PART NUMBER

ZDIGMUX100
UPC
081159830120

SUPPLIED WITH

Integral mounting brackets, 0.75m
Power/Data cable and User Manual

PRICE

\$ 165.00

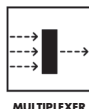

MULTIPLEXER



INTERFACE

WL70 WI-FI BOOSTER

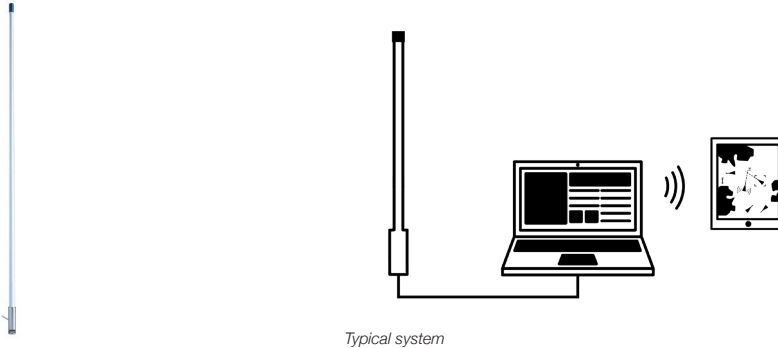

“Just missing that network connection – the WL70 has a high gain 15dBm antenna that sucks in the weakest of Wi-Fi signals allowing connection where ever you are in the marina. Ships with easy USB connection cable and integral 1” x 14TPI VHF thread mount”

Wi-Fi range depends on many local factors, but Digital Yacht has seen ranges of up to 1 mile with this low cost system. In general, using an internal Wi-Fi adaptor typically found on a notebook, you'll be lucky to find the signal at the end of the dock, so if you plan to access the internet whilst on board, the WL70 could be the solution for you.

KEY FEATURES

This compact all-in-one system features a very hi-gain (15dBm) antenna with a 5m (16ft) USB cable. The antenna measures 130cm (4.5ft) and should boost your Wi-Fi range to over 1.0 mile in perfect conditions.

Designed for quick and easy installation with the same standard 1” x 14TPI thread mount, as used by VHF and GPS antennas, the WL70 is an ideal temporary or permanent mount Wi-Fi solution for boats.

The WL70 connects to an on board computer via a regular USB connection with a plug ‘n’ play driver disk supplied for Windows XP/Vista/7/8/10, LINUX and Mac OS X 10.6 to 10.10 operating systems. It supports 802.11b/g/n protocols as well as WEP and WPA/WPA2 encryption.

Even if your system already has Wi-Fi access, this can be disabled and you can take advantage of the superior range (and speed) that this system will offer.

SPECIFICATIONS

- New 802.11n 100mW Wi-Fi modem
- High gain (15dBm) omni-directional antenna
- Integral 1” x 14TPI mount
- USB bus powered
- Windows XP/Vista/7/8/10 compatible
- Compatible with Mac OSX, including the latest Yosemite
- Compatible with most LINUX distros, including Raspberry Pi

DIMENSIONS

130cm (4.5ft)
(H)

PART NUMBER

ZDIGWL70
UPC
081159830458

SUPPLIED WITH

Integral 1” x 14TPI thread mount,
5m (16ft) USB cable, Driver CD and
User Manual

PRICE

\$ 199.95



WIRELESS



USB



INTERNET



WINDOWS 10



LINUX



MAC

WL510 HI-POWER WI-FI SYSTEM

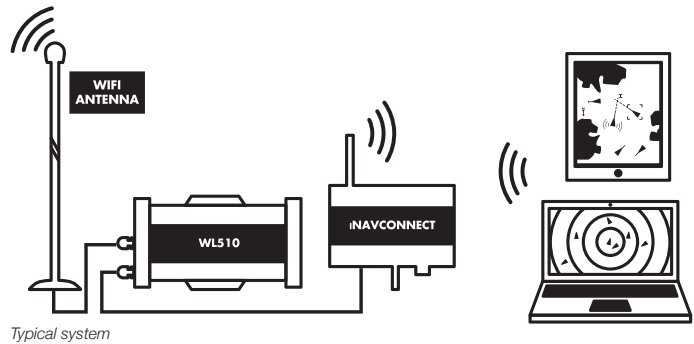

“Flagship hi power wifi connection system with ranges of 4-6NM. Features network interface for router compatibility and easy direct connection with browser interface”

KEY FEATURES

The new WL510 allows boat owners to connect to Wi-Fi hot spots so that their on board PC's or equipment can connect to the internet. With internet connectivity on board you can download the latest weather or chart updates as well as having a mobile office on board. Most harbours and ports have either free or subscription based services available.

The system has a compact, DC powered below deck mounted 600mW booster/modem and external, hi-gain (12dBm) antenna with 10m (33ft) low loss LMR400 coax interconnect cable. The antenna measures 0.9m (2.95ft) and can be supplied with deck, mast and industry standard 1" x 14TPI mountings.

The WL510 modem connects to an on board PC through a regular RJ45 CAT5 network cable for simple driver free installation. Connect the WL510 to a router and everyone on board can share the long range wireless internet connection. Compatible with all popular operating systems; Windows XP/Vista/7, Mac OS X 10.3 (and higher) and LINUX, the WL510 supports 802.11b/g protocols as well as WEP/WPA/WPA2 encryption.

Wi-Fi range depends on many local factors, but Digital Yacht has seen ranges of up to 4-6 miles with this low cost system. In general, using an internal Wi-Fi adaptor typically found on a notebook, you'll be lucky to find the signal at the end of the dock, so if you plan to access the internet whilst on board, the WL510 could be the solution for you.

SPECIFICATIONS

- Ideal solution for permanent installation and new builds
- Network Interface for connection to one PC or to a Router for shared long range connection
- Easy to setup and control from any browser through web based interface
- Adjustable (up to 600mW) Wi-Fi modem and high gain (12dBm) omni-directional antenna gives ERP up to 4W
- Supplied with threaded deck mount for antenna and 10m of low loss LMR400 coax cable
- Supplied with 1m network cable - can be extended with any CAT5 network cable (up to 50m)
- Requires connection to boats 12v DC supply
- No drivers – works with all popular operating systems; Windows XP/Vista/7/8, Mac OS X and LINUX compatible

Optional WL510-20 unit available with 20m cable.

DIMENSIONS

170mm x 107mm x 55mm
(L x W x H)
Antenna: 895mm (H)

PART NUMBER

ZDIGWL510
UPC
738435472603

SUPPLIED WITH

1m network cable, 10m Coax
Cable, Antenna, Base Mount and
User Manual

PRICE

\$ 769.95



WIRELESS



NETWORK



INTERNET



WINDOWS 8



LINUX



MAC

NAVLINK US



iPhone / iPad not included.

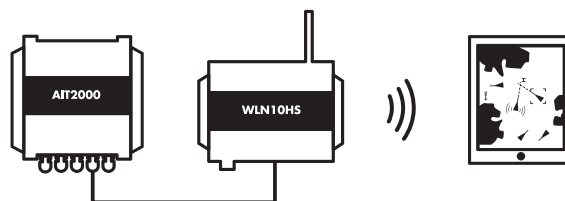

Typical system
iPad with NavLink app running



“Use your iPhone or iPad to explore, plan and navigate your boating trips in real time and in high resolution using the latest NOAA digital vector marine charts covering the whole of the US. Vector charts allow drill down on nav-aid data as well as seamless, fast panning and zooming across charts. Full integration with Digital Yacht WLN10, NavLink and iNavHub products for on board integration. Supports AIS overlays, tidal data, weather buoys and more.”

KEY FEATURES

NavLink US is a low cost app designed for use with an iPhone or iPad. It transforms your iPad into a full function chart plotter with detailed electronic charts and an overlay of your boat's position, track and heading. It's purchased through the Apple app store and includes detailed NOAA charts covering the whole of the US.

Charts can be presented north up or course up and routes and waypoints are created and edited using a simple touch screen interface. Real time navigation shows your current position, track, course, speed, ETA, VMG, bearing and distance to next waypoint. There's a simple A-B chart ruler too and you can tap on an object such as a buoy or nav-aid and get a pop up data window of its characteristics. Current weather data and local conditions can be downloaded from weather buoys (internet connection required) which is great for last minute local weather before setting off on a voyage. The latest NOAA charts are vector based so data can be layered and enabled / disabled by the user allowing charts to be de-cluttered as appropriate.

It's also designed to work seamlessly with Digital Yacht's NMEA to WiFi devices so will integrate with your boat's GPS and AIS systems. If AIS data is available, you'll see AIS targets overlaid with all their identity information and a heading line as well as alarms for CPA and TCPA.

Utilising your on board GPS with these wireless servers means you don't need a GPS enabled iPad. Even if your device is GPS enabled, it significantly reduces battery drain when using an external source. It also means your iPad/Phone can be used below deck and generally, the boat's GPS is superior for marine based navigation.

NavLink also helps with your watch keeping and lookouts. In HorizonView mode, you can use the camera on the iPad to scan the horizon. You'll get an overlay on the camera screen of nav-aids, AIS targets and waypoints which serves as a great visualisation aid.

SPECIFICATIONS

- Supports Digital Yacht WLN10, iNavHub, NavLink and iAIS products and allows boat's NMEA data to be utilised on iPad or iPhone when using this app with these devices
- North up and course up displays
- Real time tracking and track export to Google maps
- AIS overlay when connected to compatible AIS system
- Waypoints and routes with full route editing and planning function
- Position, COG, SOG, VMG, bearing, distance and ETA displays
- Configurable layers: Buoys, lights, depths contours, spot depths, wrecks, traffic zones, anchorages
- HorizonView - Overlays nav-aid and targets onto iPad/Phone camera display for easy real time viewing and location
- Automatic free chart updates included for 1 year
- Weather buoy data
- A-B chart ruler for quick and easy bearing and distance measurement
- All NOAA charts are included in the price
- Tide and sunrise/set displays
- UK version also available (NavLink UK)



NavLink US

In navigation view you can see your current route and active waypoint (indicated with a star). The data window shows waypoint bearing and distance, course, ETA and VMG and the arrow keys allow you to jump to the next or previous waypoint. Your position is updated in real time together with track information which can be toggled on or off. AIS targets are overlaid when connected to a compatible AIS system. NavLink – easy marine navigation for an iPhone or iPad



AIS target overlay

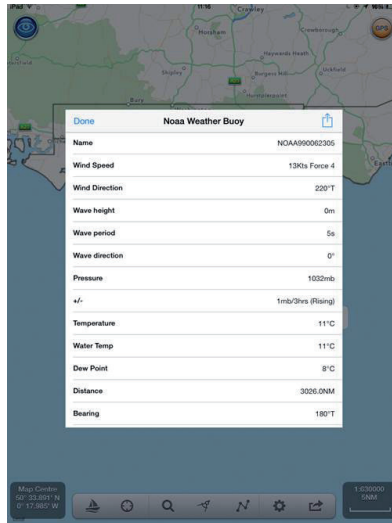

Weather buoy data

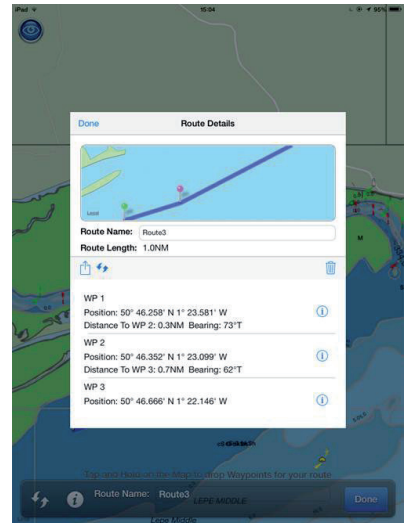

Route planning

DIMENSIONS

N/A

PART NUMBER

N/A

UPC

N/A

SUPPLIED WITH

N/A

PRICE

Consult the App Store.



IOS

NAVLINK MAC

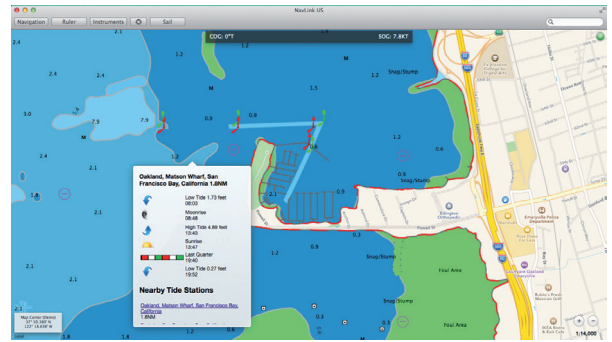

KEY FEATURES

NavLink MAC is an Apple MAC based electronic charting and navigation package which turns a MacBook into a full function chart plotter. The application comes complete with highly detailed NOAA vector charts for the whole of the US and allows real time positioning, tracking and routing. Simply create a route with a click of the mouse to quickly and easily get bearing, distance and ETA information to your destination. AIS targets can also be overlaid onto the electronic charting. Charts can be zoomed and panned using intuitive finger gestures on the MAC track pad.

The MAC will require a GPS connection for location and optional connection to AIS if an AIS overlay of targets is required. Digital Yacht's range of GPS sensors or their low cost USB-NMEA adaptor can be utilised to connect the MAC to the boat's GPS/AIS system. Alternatively, for a wire free solution, NavLink supports a connection via wifi to any of Digital Yacht's NMEA to wireless devices such as iAIS and the WLN10.

The NOAA charts feature incredible detail as they are the official digitised versions of the US Government charts and show buoys, nav aids, depth contours, wrecks, spot depths, restrictions etc. It also supports "drill down" data so an object such as a buoy can be queried for its characteristics. Weather buoys are also supported for local weather conditions (an internet connection is

required for this live data) and a tidal atlas is included. NavLink has been designed from the ground up to take advantage of the MACs simplicity of operation and clarity of the high resolution displays on Apple's latest products.

SPECIFICATIONS

- Detailed vector NOAA charts covering the whole of the US
- GPS and AIS interfaces via USB or WiFi (compatible with Digital Yacht's NMEA to wifi devices and NMEA to USB adaptor)
- Superfast screen redraws and intuitive panning and zooming thanks to the MacBook's OS
- A-B chart ruler
- Drill down chart information
- Create waypoints and routes and share routes with others
- Export and share routes with the NavLink iOS app
- Weather buoy and tidal data
- Real time GPS tracking
- AIS target overlays with CPA and TCPA alarms
- Chart Printing

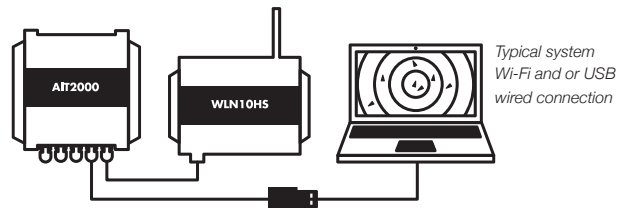

DIMENSIONS

N/A

PART NUMBER

N/A

UPC

N/A

SUPPLIED WITH

N/A

PRICE

Consult the Mac App store.



MAC

AISVIEW ANDROID APP

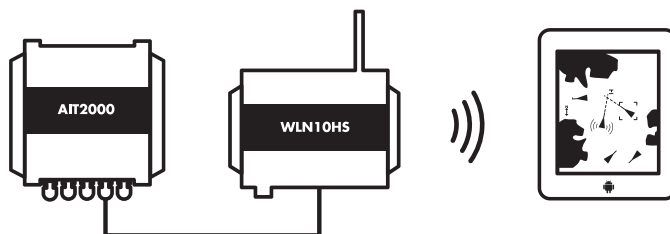

Typical system
Android tablet with AISView connected to
boats NMEA system via WLAN10



KEY FEATURES

AISView is the ideal App for anyone wanting to display “live” AIS data from their boat’s AIS receiver or transponder on their Android tablet or smart phone. AISView is designed to receive and display wireless NMEA data from any of Digital Yacht’s NMEA to Wifi devices like the WLAN10, NavLink, iNavHub or iAIS.

Although a “wire free” connection is the easiest way to get data in to the tablet, if you do not have one of our wireless NMEA products, you can also connect using Digital Yacht’s USB-NMEA adaptor. Connect this cable to the NMEA0183 output of your AIS and plug the USB connector in to a suitable USB OTG cable for your tablet and you have a simple and cost effective method of getting AIS data in to the tablet

Even if you have a full featured AIS display on your main plotter, having an extra display on a tablet is useful as a repeater or 2nd display. Utilising the internal GPS of the Android tablet, you will also have a completely separate backup system, which should your main plotter fail, will display your position, all of the AIS targets around you and also provide anti-collision alarms with CPA and TCPA calculations.

Once installed, you’ll see an overlay of AIS target information onto a background Google map. Tap on a target and you’ll get a drop down list with identity, heading and closest point of approach (CPA) information. A heading vector makes it easy to see potential collision

course targets. Google maps can now be cached if you don’t have an internet connection but even if this feature is not used, AISView will present an attractive radar like visualisation with range rings overlaying the targets around your vessel.

AISView also supports a simple bearing and distance ruler, compass heading display and current position and track history from the device’s built in GPS. Alarms can be configured for closest point of approach and AIS SARTs – useful for MOB applications. If you have a live internet connection, you can also supplement the real time overlay with AIS information obtained from the popular BoatBeacon internet AIS app (if this is installed) allowing you to view AIS targets in remote ports or locations.

SPECIFICATIONS

- AIS viewing app for Android phones and tablets
- Available to purchase in the Google Play store
- Radar like display of AIS targets with range rings and chart grid
- Background Google mapping if available
- Supports TCP/UDP wireless connection (compatible with WLAN10, NavLink and iAIS)
- Also supports USB connection with driver support for USB-NMEA adaptor
- A-B chart ruler
- Alarms for CPA and TCPA

REQUIREMENTS

Android Smartphone or Tablet with GPS.
A wireless NMEA (TCP or UDP) AIS data connection or a compatible USB to NMEA adaptor cable and OTG USB Cable.

PART NUMBER

N/A
UPC
N/A

SUPPLIED WITH

N/A

PRICE

Available on the Google Play store.
Just search for AISView



iNAVCONNECT WIFI ROUTER



iNavConnect acts as a perfect wifi gateway for Fusion 700 series audio systems and their iPhone app – seamless wifi control of your boat's stereo system from an iPhone or iPad

“The perfect router for afloat with DC power, slick interface and support for multiple users. Data transfer and Fusion marine stereo remote control apps”

KEY FEATURES

iNavConnect is an all in one solution for setting up a wireless network on your boat. With direct connection to the boat's 12v or 24v DC, higher gain 5dB antenna and a rugged IP54 black box, iNavConnect can be easily fitted to any vessel.

iNavConnect also supports the Fusion app allowing a connected iPhone or iPad to control the Fusion stereo connected to the LAN on the iNavConnect.

Full integration with Digital Yacht's latest WL510 long range Wi-Fi adaptor is also possible. Simply plug the WL510 in to the dedicated network socket and when you arrive in port and connect the WL510 to the marina's hotspot, everyone on board will be able to share the long range internet connection.

SPECIFICATIONS

- 12/24v DC Powered Wireless Router
- Pre-configured and optimised for connection to Raymarine E Series network
- Integrates with Digital Yacht's latest WL510 long range Wi-Fi Adaptor
- When connected to WL510, will allow the long range internet connection to be shared with everyone on board
- Creates an 802.11n wireless network onboard with full WEP/WPA/WPA2 encrypted password protection
- 5dB detachable antenna
- Easy to install IP54 black box solution

DIMENSIONS

244mm x 150mm x 60.5mm
(L x W x D)

PART NUMBER

ZDIGINC
UPC
030955183640

SUPPLIED WITH

1m Power cable, 1m Network Cable, Wifi Antenna and User Manual

PRICE

\$ 249.95



WIRELESS



NETWORK

iNAVHUB WIFI ROUTER AND NMEA WIFI SERVER

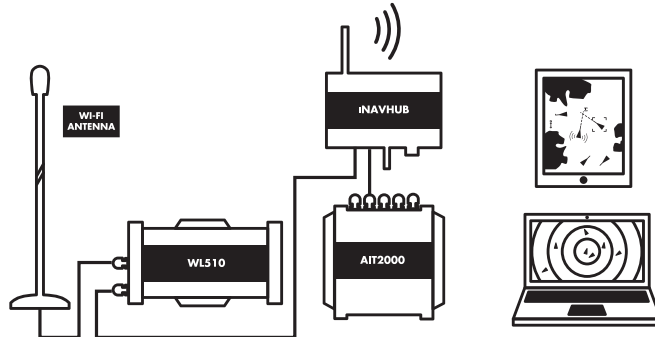

Typical system

“Your on board wireless hub with NMEA interface for navigation systems and WAN interface for internet access devices such as our WL510. Step on board and connect and you’ll have one network with all your data”

KEY FEATURES

iNAVHub combines wireless networking and wireless NMEA data transfer in one simple to install box. Similar to our popular iNav-Connect product, it creates a wireless network onboard the boat that any wireless device can connect to.

Once connected, iPhones, iPads, PCs and Macs, can receive NMEA0183 data wirelessly for use in iNavX and other navigation apps, whilst also sharing the long range internet connection created by Digital Yacht’s WL510 product.

iNAVHub is designed to fully integrate with Digital Yacht’s latest WL510 long range Wi-Fi adaptor. Simply plug the WL510 into the dedicated network socket and when you arrive in port and connect the WL510 to the marina’s hotspot, and everyone on board will be able to share the long range internet connection.

SPECIFICATIONS

- 12/24v DC Powered Wireless Hub
- All-in-one solution for distributing your wireless internet and NMEA data
- Integrates with Digital Yacht’s latest WL510 long range Wi-Fi Adaptor
- When connected to WL510, will allow the long range internet connection to be shared with everyone on board
- Includes an NMEA interface that outputs NMEA0183 data wirelessly to multiple iPhones, iPads, PCs, etc. via UDP
- Creates an 802.11n wireless network onboard with full WEP/WPA/WPA2 encrypted password protection
- 5dB detachable antenna
- Easy to install IP54 black box solution

EXTRA APPLICATIONS



iNAVHub is the perfect partner to iNavX

DIMENSIONS

244mm x 150mm x 60.5mm
(L x W x D)

PART NUMBER

ZDIGINH
UPC
030955183855

SUPPLIED WITH

1m Power cable, 1m Network Cable, Wifi Antenna and user Manual

PRICE

\$ 499.95



WIRELESS



NETWORK



INTERFACE

MARINE PC SYSTEMS

AQUA 2 STANDARD PC



“Stunning performance from this solid state marine PC – ideal for charting, monitoring of office applications aboard. Easy navigation hook up with dual NMEA ports and ultra-low current consumption”

KEY FEATURES

Aqua Standard is designed as a general purpose, great value on board PC. With two NMEA ports, a 64GB solid state hard drive, 4 GB of RAM and a CD/DVD RW drive. Standard connections include four USB ports, a VGA and HDMI port allowing the system to drive up to two compatible LCD monitors and all the standard system connectors for keyboard, audio and network.

Featuring the latest ultra low power, fanless, Intel Atom N2800 processor (6.5W) the complete Aqua PC system typically consumes around 12W, but provides all of the PC performance you need to run your navigation software, e-mail, surf the web etc.

All Aqua PCs are supplied with Windows 8 (32bit) and feature high efficiency DC-DC converters that allow them to be connected directly to the boat's 12v DC supply with no inverter.

The Aqua Standard PC can be supplied with optional built-in Hi-Power Wi-Fi adaptor or built-in NMEA 2000 gateway.

SPECIFICATIONS

- 12v DC powered, ultra rugged marine PC
- Fanless design and solid state hard drive, provide totally silent and reliable operation
- Compact - measures just 30cm x 27cm x 7cm!
- Ultra low power consumption Intel Atom N2800 processor for low power consumption and fast computing
- Supplied with Windows 8 home premium operating system (on UK versions)
- 2 x NMEA Ports and 4 x USB Ports (2xUSB3)
- Easy mounting and installation
- Fitted with CD/DVD RW
- 64GB solid state hard drive

DIMENSIONS

300mm x 270mm x 70mm
(L x W x H)

PART NUMBER

ZDIGAQU200
UPC
030955183794

SUPPLIED WITH

0.75m Power/IO cable, Bulkhead mounting brackets, Windows 8 DVD

PRICE

\$ 1199.95



DVD



WINDOWS 8



SOLID STATE DRIVE



USB



INTERFACE



NETWORK



LOW POWER

AQUANAV 2 PC



“With built in AIS and GPS sensors, AquaNav is the perfect choice for an on board navigation PC”

KEY FEATURES

The AquaNav PC is designed as a powerful marine navigation PC, with two NMEA ports, a super fast 64GB solid state hard drive, 4 GB of RAM, built-in dual channel AIS receiver, dedicated GPS Antenna and a CD/DVD RW drive. Standard connections include four USB ports, a VGA and HDMI port allowing the system to drive up to two compatible LCD monitors and all the standard system connectors for keyboard, audio and network.

Featuring the latest ultra-low-power Intel Atom N2800 processor (6.5W) the complete Aqua PC system typically consumes around 12W but provides all of the PC performance you need to run your navigation software, e-mail, surf the web, etc.

All Aqua PCs are supplied with Windows 8 (32bit) and feature high efficiency DC-DC converters that allow them to be connected directly to the boat's 12v DC supply with no inverter.

The AquaNav PC can be supplied with an optional built-in Hi-Power Wi-Fi Adaptor or built-in NMEA 2000 gateway.

SPECIFICATIONS

- 12v DC powered, ultra rugged marine PC
- Fanless design and solid state hard drive, provide totally silent and reliable operation
- Built-In dual channel high sensitivity AIS receiver
- Supplied with smart GPS antenna that connects on dedicated IO cable
- Pre-configured and interfaced so GPS and AIS work straight out of the box
- Compact - measures just 30cm x 27cm x 7cm
- Ultra low power consumption Intel Atom N2800 processor for low power consumption and fast computing
- Supplied with Windows 8 home premium 32bit operating system (on UK versions)
- 2 x NMEA ports and 4 x USB ports (2xUSB3)
- Easy mounting and installation
- Fitted with CD/DVD RW
- 64GB solid state hard drive

DIMENSIONS

300mm x 270mm x 70mm
(L x W x H)

PART NUMBER

ZDIGAQU200N
UPC
030955183800

SUPPLIED WITH

0.75m Power/IO cable, 0.75m
Navigation IO cable, Bulkhead
mounting brackets, GPS Smart
Antenna, Windows 8 DVD

PRICE

\$ 1599.95



DVD



WINDOWS 8



SOLID STATE
DRIVE



USB



INTERFACE



NETWORK



LOW POWER



GPS



AIS

MARINE PC SYSTEMS

AQUAPRO 2 PC



“Ideal for use with power hungry 3D charting and bathymetric software. Superfast performance”

KEY FEATURES

The new Aqua range of marine PCs from Digital Yacht bring affordable low power computing to every boat. All models utilise the latest generation of Intel or AMD processors and a highly efficient DC power supply to offer exceptionally low power consumption as well as ultra fast computing capabilities, especially on our latest AquaPro 2 model, built around the AMD A6-3500 processor.

AquaPro is designed specifically for high speed, demanding 3D charting and bathymetric applications and has been successfully tested on the latest MaxSea TimeZero technology. It utilises the latest AMD Fusion APU technology and for exceptional performance. It's supplied with 8GB RAM, 6 USB ports (including 2 x USB3.0), Windows 8 (64 bit) as standard and can also be fitted with an internal 4 port isolated NMEA interface with built in multiplexing functions. This allows complex NMEA systems to be integrated into the PC. A 64GB solid state hard drive is supplied as standard and an 802.11n wireless adaptor for easy networking.

When not being used for navigation, it also features a DVD/CD drive, 1080P HDMI output and Dolby 7.1 surround sound for excellent media playback of DVDs and music.

SPECIFICATIONS

- 12/24v DC powered, ultra rugged marine PC
- Latest AMD A6-3500 processor for exceptionally fast processing speeds
- Integral Radeon HD65XX graphics for fast 3D performance on MaxSea TimeZero
- 8GB RAM
- Compact - measures just 30cm x 27cm x 7cm
- Low power consumption with remote turn on/reset capability and auto shut down
- Supplied with Windows 8 64 bit Home Premium operating system (on UK versions)
- 6 x USB Ports
- Easy mounting and installation
- 64GB solid state hard drive

DIMENSIONS

300mm x 270mm x 70mm
(L x W x H)

PART NUMBER

ZDIGAQU100P
UPC
738435472498

SUPPLIED WITH

0.75m Power, Bulkhead mounting brackets, Windows 8 DVD, Driver CD and User Manual

PRICE

\$ 2099.95



DVD



WINDOWS 8



SOLID STATE DRIVE



USB



NETWORK

AQUA ADAPT PC & INTERFACE OPTIONS



Aqua Adapt PC



Aqua Adapt Navigation Interface



Aqua Adapt Communication Interface

“Powerful modular marine PC system for navigation, communication and entertainment applications on board”

KEY FEATURES

Aqua Adapt is a new modular PC system designed to optimise PC integration into onboard navigation, communication and entertainment systems. It's based around a central PC processor utilising a powerful Intel i3 core with 8GB RAM and a 64GB solid state drive. Its fanless design makes for totally silent, super reliable operation. What's more it only consumes around 20W of power. The Adapt series is designed to connect direct to the boat's DC battery system and operates from 8–19v DC. It ships as standard with Windows 8 64 bit preloaded and has built in 802.11 b/g/n WIFI and a wired 1GB network port

Aqua Adapt's modular approach makes integration easy. The Adapt Navigation interface incorporates a certified NMEA 2000 interface as well as a dual channel NMEA 0183 interface (4800/38400 baud) allowing quick and easy integration into onboard NMEA networks. It's also fully compatible with our Navionic's based SmarterTrack 2015 software so expanding an on board navigation system and taking advantage of powerful PC features has never been easier.

Also available is the Aqua Adapt Communication interface which

incorporates a high power wifi internet access system and is supplied with 15dBI external wifi antenna and 10m LMR400 cable. This system add on allows internet access afloat via wifi hotspots and can offer ranges of up to 5NM depending upon conditions and the hotspot capability. It connects to the Aqua Adapt processor via a simple RJ45 network connection.

INTERNAL WIFI

The internal wifi card of the Adapt PC can be configured to act as a server for remote display application such as Splashtop. This allows a tablet or iPad to act as a wireless remote display for the PC. It can also act as a wifi router for the Adapt AD30 Communications interface allowing multiple users to share the internet connection.

BRING OUT NETWORK CONNECTIONS USING OUR PANEL MOUNT RJ45 CONNECTOR

This neat panel mount connector is ideal for network connections at the chart table or even throughout the boat. It fits quickly and neatly into a 25mm hole and is ideal for data, network and voice RJ45 connections. They make networking a boat with cat 5 cabling a simple reality.



RJ45 panel mount connector
X500.088

DIMENSIONS

170mm x 110mm x 65mm
(L x W x H)

UPC

Adapt PC
081159830144
Adapt Navigation Interface
081159830151
Adapt Communication Interface
081159830168

PART NUMBER

ZDIGAQAD
ZDIGAQAD20
ZDIGAQAD30

PRICE

\$ 1495.00
\$ 625.00
\$ 825.00

SUPPLIED WITH

Windows 8 pre loaded



WINDOWS 8
40



SOLID STATE
DRIVE



USB



NETWORK



LOW POWER

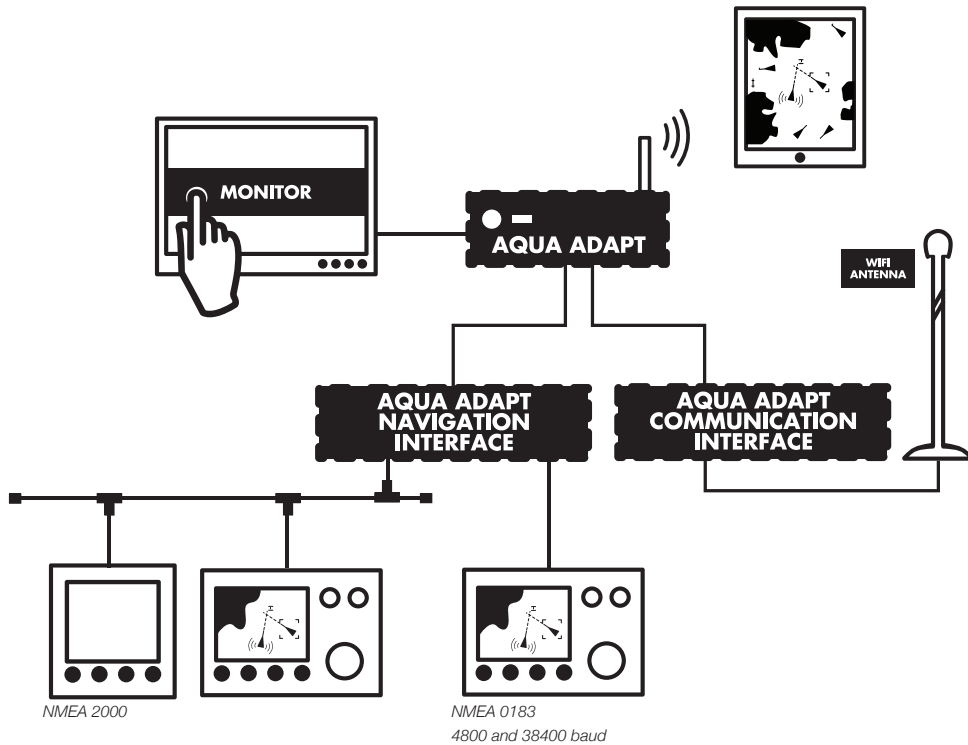

Typical system

SPECIFICATIONS

AQUA ADAPT PROCESSOR

- Modular powerful PC system – ideal for on board navigation, communication and entertainment applications
- Comprises central PC processor with additional modules incorporating on board interfaces
- Fanless design for excellent reliability
- 8-19v DC input, approx 20W power consumption
- Powerful Intel i3 processor with HD4000 graphics
- 8GB DDR3 1600MHz SO-DIMM memory and super fast 64GB solid state drive
- Dual HDMI video out for two independent monitors
- Integrated 802.11 B/G/N wifi
- 3 x USB ports
- Windows 8 64 bit operating system
- Just 170mm x 110mm x 65mm

AQUA ADAPT NAVIGATION INTERFACE

- Integrates Aqua Adapt into on board NMEA 2000 systems
- Provides certified NMEA 2000 to Aqua Adapt processor interface via USB
- Also features dual NMEA 0183 interface (4800 and 38400 baud compatible) to Aqua Adapt processor
- Fully compatible with SmarterTrack 2015
- 8-19v DC input

AQUA ADAPT COMMUNICATION INTERFACE

- Hi power wifi internet access for the Aqua Adapt
- Connects via supplied LAN network cable
- Supplied with 10m LMR400 antenna cable (20m option)
- Supplied with 1m 15dBi high gain wifi antenna and base
- Offers internet wifi connectivity up to 5NM depending upon conditions
- 8-19v DC input

AQUAMEDIA AQM200 ENTERTAINMENT SERVER

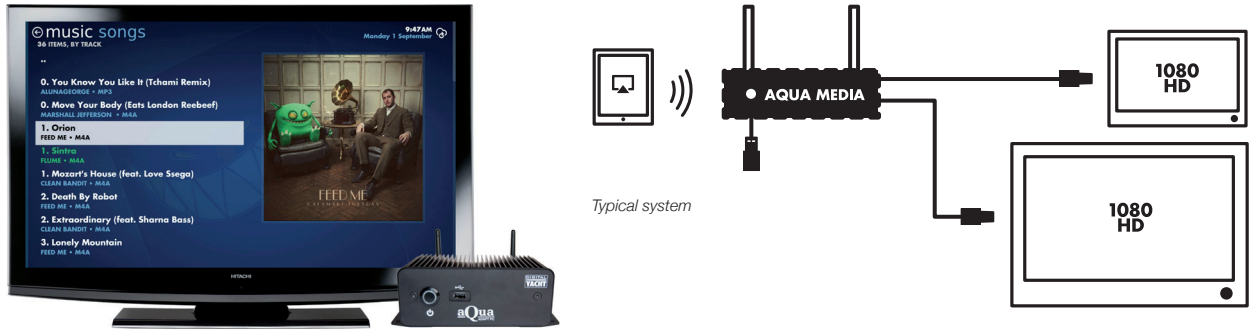

“A great solution for on board digital entertainment”

KEY FEATURES

AquaMedia is an on-board media server designed to bring the latest in entertainment technology to your boat. Playback music, video, pictures or internet TV and integrate with your audio and TV systems. With a stunning, easy to use interface and blisteringly fast processor, AquaMedia brings you the best and latest in media entertainment afloat. Simply step on board and plug in your USB pen drive or hard disk that contains your audio, video and photo media for on board playback. AquaMedia will quickly index the drive and logically arrange the media through its custom operating system. All your media is then beautifully presented within an easy to use interface.

It's super compact, silent and totally solid state and it is powered direct from the boat's DC system so there's no need for inverters. Connect AquaMedia via HDMI to your choice of TV or display or via an AUX connection to the boat's audio system – this allows your existing stereo and speakers to integrate with the latest digital entertainment. AquaMedia can support up to two HDMI video connections with independent resolutions allowing one system to offer saloon and cabin playback.

Connect to the internet for web and internet TV functionality via

built in wifi or through the WL510 high power wifi solution from Digital Yacht. It has a wired network connection too for integration with bigger networks. AquaMedia also supports audio playback via AirPlay on iOS devices like iPhones and iPads. The menu offers support for up to 4 IP video cameras allowing the TV to offer security, navigation or thermal camera views.

AquaMedia ships with a compact wireless keyboard and trackpad and is also compatible with FLIRC IR adaptors (available as an option) so the TV remote can be used as a controller.

SPECIFICATIONS

- Hi performance Intel i3 based processor for exceptionally fast and easy operation
- Super fast indexing and playback of digital media
- Totally solid state and passively cooled with no moving parts
- 8-19V DC operation
- Dual HDMI video interfaces
- Built in 801.11b/g/n wifi
- Built in BlueTooth 4
- Supports up to 4 IP cameras
- 10/100/1000MB wired network interface

DIMENSIONS

170 x 110mm
(L x W x H)

PART NUMBER

ZDIGAQM200

UPC

081159830328

SUPPLIED WITH

RF Keyboard and trackpad
Note TV not included

PRICE

\$ 1495.00



SOLID STATE DRIVE



USB



WIRELESS



NETWORK



INTERNET



TELEVISION



AUDIO



MP4



AIRPLAY



NETFLIX

AQUAMEDIA AQM200 ENTERTAINMENT SERVER

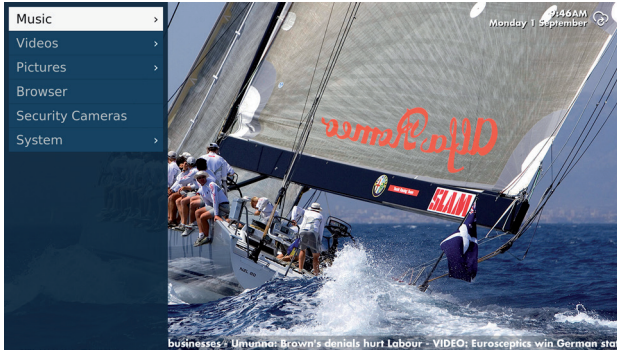

MAIN MENU

AquaMedia boots in seconds to an intuitive menu and allows easy keyboard or remote control operation

NEWS FEED

Tickertape feed of news at bottom of screen and Twitter feed at top

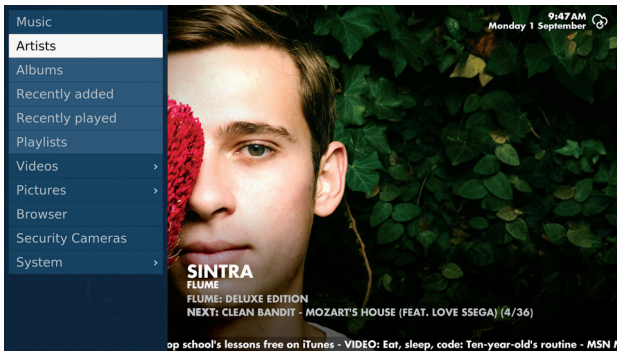

MEDIA INDEXING

Bring your audio, video and pictures on any USB storage device and AquaMedia will index the files into a logical playback system. Album and cover artwork are downloaded if an internet connection is available



RAZOR INTERFACE

Easy operation even in rough seas thanks to Digital Yacht's razor interface

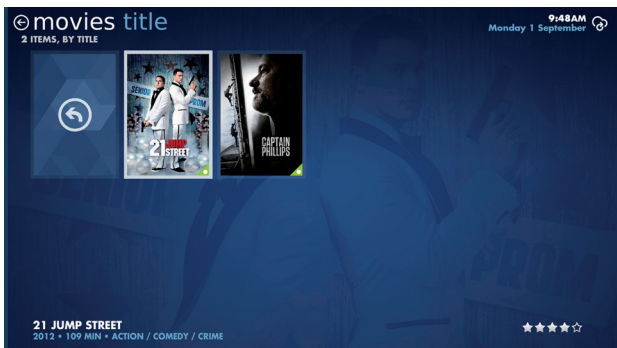

VIDEO PLAYBACK

Have unlimited access to music and videos with a universal USB interface

DTV100 MARINE HDTV & FM ANTENNA



A high performance, omni-directional HD TV antenna that lets you start taking advantage of free to air HD digital TV signals

KEY FEATURES

The DTV100 features a unique antenna design that provides high gain, omni-directional reception of both vertically and horizontally polarized digital TV signals. Designed for marine use, with a pole mount or 1" x 14TPI thread mount adaptors, the antenna is waterproof to IP68 and is constructed from ultra tough UV resistant ABS casing, designed to be permanently mounted on the boat.

With a 10m (33ft) low loss RG6 cable, that is terminated in a slim F-Type screw connector, for easy routing through tight spaces and secure and reliable connection to the DTV100 amplifier box.

The DTV100 features a variable amplifier (-7dB to +29dB) that can attenuate really strong signals for when you are close to a TV transmitter (to avoid distortion) and that can also significantly amplify weak signals when you are in more remote locations.

The amplifier can work from a 12v or 24v DC boat supply, features a useful on/off switch and has a green LED power indicator. The standard amplifier has one TV output and one FM radio output, while the optional dual channel amplifier can drive two TVs and an FM radio.

Most countries are now transmitting free to air digital TV channels (including many HD services) and the DTV100 ensures you get perfect reception where ever your boating may take you

SPECIFICATIONS

- Very high performance omni-directional digital TV antenna
- Waterproof to IP68, tough UV resistant casing that is designed for permanent mounting on the boat
- Global reception capability of latest digital DVB/HDTV signals
- Pole and 1" x 14TPI thread mount adaptors
- 1 x TV and 1 x FM radio outputs as standard
- Optional 2 x TV and 1 x FM radio amplifier accessory
- Variable gain below deck amplifier unit (-7dB to +29dB) with integral On/Off switch and power indicator
- 10m RG6 cable with slim and secure F-Type connector
- 12v or 24v DC operation (typicall 20-60mA)

DIMENSIONS

280mm diameter x 200mm high
(Dia x H)

PART NUMBER

ZDIGDTV100

SUPPLIED WITH

Pole and 1" x14TPI thread mount adaptors, 10m cable, amplifier, power lead and fixings

PRICE

\$ 199.95

UPC

081159830427



TELEVISION



AUDIO

USB TO NMEA ADAPTOR

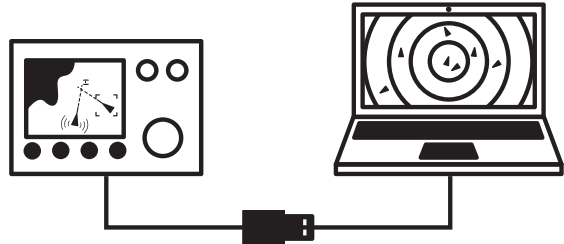

Typical system

“Get NMEA data into your PC or MAC with this super stable interface”

KEY FEATURES

The NMEA to USB Adaptor works on PCs, Macs and Linux computers, and converts NMEA 0183 data, used by many marine systems, into a USB format that can be plugged into most modern computers.

The adaptor is a bi-directional device so data can be sent to and from systems and supports traditional 4800 baud data or the higher speed 38400 baud rate used by AIS systems. LEDs show data being received and transmitted which helps with interfacing issues and all the electronics are encapsulated into the connector. The device creates a virtual COM port on the PC which navigation and charting software can use to read NMEA data. Multiple adaptors can be connected if necessary which effectively allow any number of NMEA ports to be created on your PC.

The device ships with a multi platform driver CD so it can be used on PCs, MACs and even Linux based systems. If you're using the device with an AIS, you'll get a bonus as SmarterTrack Lite AIS viewing software is included on the CD - effectively turning your PC into an AIS target display.

SPECIFICATIONS

- Converts NMEA0183 into USB so that your computer can read the data
- Bidirectional data conversion
- Use with our GPS150 for PC integration
- Low cost simple solution
- More than one adaptor can be fitted to the computer
- 4800, 9600, 38400 and 115200 baud compatible
- Built-in indicator lights flash to show data is being received and transmitted
- Easy plug and play connection to most computers
- Comes with a driver CD and a free copy of SmarterTrack Lite AIS software

DIMENSIONS

1.8m cable

PART NUMBER

ZDIGUSBNMEA

UPC

030955183671

SUPPLIED WITH

1.8m Cable, Manual and CD

PRICE

\$ 59.95



USB



INTERFACE



WINDOWS 8



LINUX



MAC

SMARTERTRACK LITE SOFTWARE

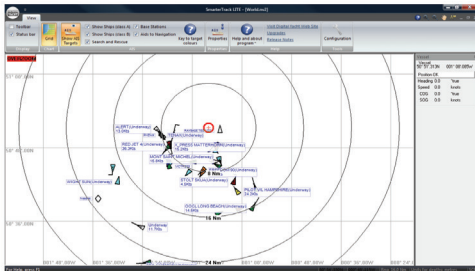

“Supplied free with our AIS systems, this is a great PC viewer for AIS systems”

KEY FEATURES

SmarterTrack LITE is a simple, but effective graphical AIS display program for PCs. The data collected by AIS units is meaningless without some sort of graphical display that shows where the AIS targets are in the real world, relative to your vessel.

SmarterTrack LITE does just this by plotting all surrounding AIS targets on a world map or, as you zoom in, on a blank radar type screen with variable range rings.

Designed to give customers an immediate taste of what AIS is all about, SmarterTrack LITE can then be upgraded to the full version as and when required.

AIS support includes; colour coded targets, user selectable labelling of targets, target course lines and fast AIS Information recovery, making it the ideal introduction to AIS software on the market. SmarterTrack LITE can be used on any PC running a Windows XP/ Vista/7/8 operating system.

SPECIFICATIONS

- Simple graphical AIS display software for PCs
- Plots all detected AIS targets on world map
- Automatically switches to AIS “Radar” type display as you zoom in
- Colour coded AIS Targets with course lines
- Each AIS target shown with user selectable label
- Allows easy programming of Class A Transponder voyage data
- Will display wireless NMEA 0183 data from Digital Yacht’s iAIS, WLN10 and Boatranet products
- Can be upgraded to full SmarterTrack package

DIMENSIONS

N/A

PART NUMBER

ZDIGSTLTE

UPC

N/A

SUPPLIED WITH

Installation CD-ROM and manual

PRICE

(Free with all AIS and AquaPC units)



WINDOWS 8

SMARTERTRACK 2015 SOFTWARE

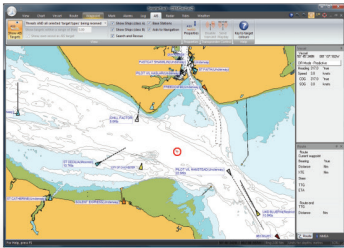

Navionics charting

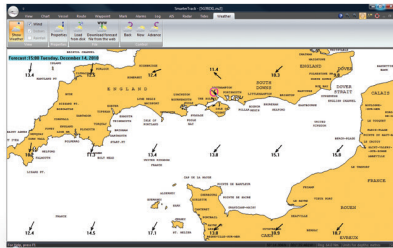

Weather overlay

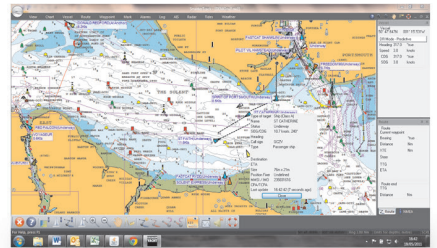

Sophisticated AIS overlay

“Easy to use PC navigation software compatible with Navionics charts. Powerful features and AIS enhanced displays”

KEY FEATURES

SmarterTrack is the ideal PC navigation software for anyone who has a dedicated chart plotter that uses Navionics Gold and Platinum chart cartridges or who is new to electronic charting and wants simple to use PC navigation software with good AIS support.

Planning at home, monitoring from the chart table or as a self contained independent backup system, SmarterTrack turns your PC in to an invaluable navigation tool that will display your GPS position and the location of all the surrounding AIS targets on the accurate and detailed Navionics electronic charts.

AIS support includes; colour coded targets, user selectable labelling of targets, fully configurable CPA and TCPA alarms, visual indication of CPA, AIS targets drawn to scale and many other other settings and features that make this software ideal for displaying AIS data. Entering the route you wish to sail, checking the tides, overlaying weather (GRIB files), confirming depths or nav-aids on the chart and a whole host of other routine navigational tasks can be performed simply and effortlessly with SmarterTrack. SmarterTrack now also supports Navionics’s Sonar charts which give highly detailed sub-sea information and additional depth

contours generated from user supplied local data. SmarterTrack can also utilise the internal wifi adaptor on Aqua PCs to support apps like Splashtop which allow remote display mirroring on iPads and tablets – perfect as a 2nd station display. On this latest version, Navionics’s charts can be copied to the PC hard drive allowing charts to be shared between plotter and PC with no additional costs. Navionics’s charts are widely used by Lowrance, Raymarine, Simrad, B&G and Humminbird plotters so SmarterTrack makes an ideal partner to an on board plotter.

SPECIFICATIONS

- Simple yet powerful PC Navigation software
- Supports Navionics’s Gold or Platinum chart cartridges – NOTE ONLY charting features supported not 3D capability of Platinum
- Now compatible with Navionics Smart Charts
- Excellent AIS support
- Full set of configurable alarms
- Displays tidal height and tidal flow data
- Optimum departure time capability from tidal data
- All route and waypoint data created on SmarterTrack can be transferred to your dedicated chart plotter
- Displays all NMEA 0183 instrument data
- Allows import of downloaded weather GRIB files
- Will display wireless NMEA 0183 data from Digital Yacht’s iAIS, WLN10 and Boatranet products

DIMENSIONS

N/A

PART NUMBER

ZDIGSTPCN

UPC

738435472566

SUPPLIED WITH

installation CD-ROM

PRICE

\$ 399.95



DVD



NAVIONICS

BOATraNET

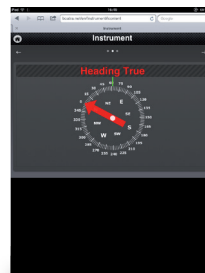
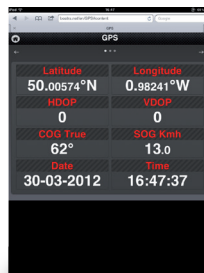
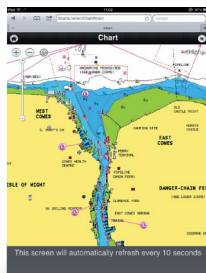

Typical browser screen shots

“On board wireless web server with custom interface. Puts all your boat’s data into a web browser on any mobile device with navigation, charting, documents, media and more”

KEY FEATURES

BOATraNET is a truly unique and innovative product that “e-enables” your existing navigation system and creates a dynamic, local intranet for your boat. Imagine having your own automatic website that shows visitors to your boat, all of the most important navigational information and gives them access to the photos, documents and music that you want them to share and enjoy. BOATraNET integrates with the boat’s existing navigation system (Raymarine, Garmin, Furuno, Navico, etc.) via NMEA 0183 and automatically creates animated instrument and navigational displays (web pages) of your data.

It creates a wireless “hotspot” that works with iPhones, iPads, iPod Touch, Android Devices, Smart Phones, Laptops, Windows, LINUX and Mac OS X PCs. Anyone onboard can connect, enter the password you give them, and then using the wireless device’s own web browser (no special app required) view the data, even when out at sea without an internet connection.

BOATraNET incorporates a Navionics based chart plotter (with optional embedded Silver Charts), that shows you where you are on the chart, a music player that can play music on your boat’s hifi or stream music to your wireless devices, plus photo and document viewers that you control from your wireless device’s web browser. Connect BOATraNET to one of Digital Yacht’s long range wifi adaptors and when you are in the marina, you can easily connect to the marina’s “hot spot” and share the long range wifi connection, with everyone connected to BOATraNET.

Continued overleaf

BOATraNET is fully expandable and more functions, features and accessories are planned to be rolled out over the coming months. Software updates, data and media files can easily be transferred via USB memory sticks.

SPECIFICATIONS

- World’s first wireless navigation server for boats
- Creates dynamic HTML 5 compliant web pages that can be accessed by anyone on the boat
- New and exciting method for family and friends to access data and media whilst onboard
- Can be accessed by any wireless device with a modern browser – no special apps required
- Works everywhere at sea – no internet connection required
- Optional long range wifi adaptor for shared internet connection in marinas (WL510)
- 12/24v DC, ultra rugged, fanless hardware that consumes just 1A
- Compact - measures just 29.5cm x 22.5cm x 6.2cm
- 2 x NMEA 0183 Ports
- Easy mounting and installation
- All units include a worldwide Base Map
- Can be supplied with optional Navionics Silver continental chart coverage of your region

Typical system

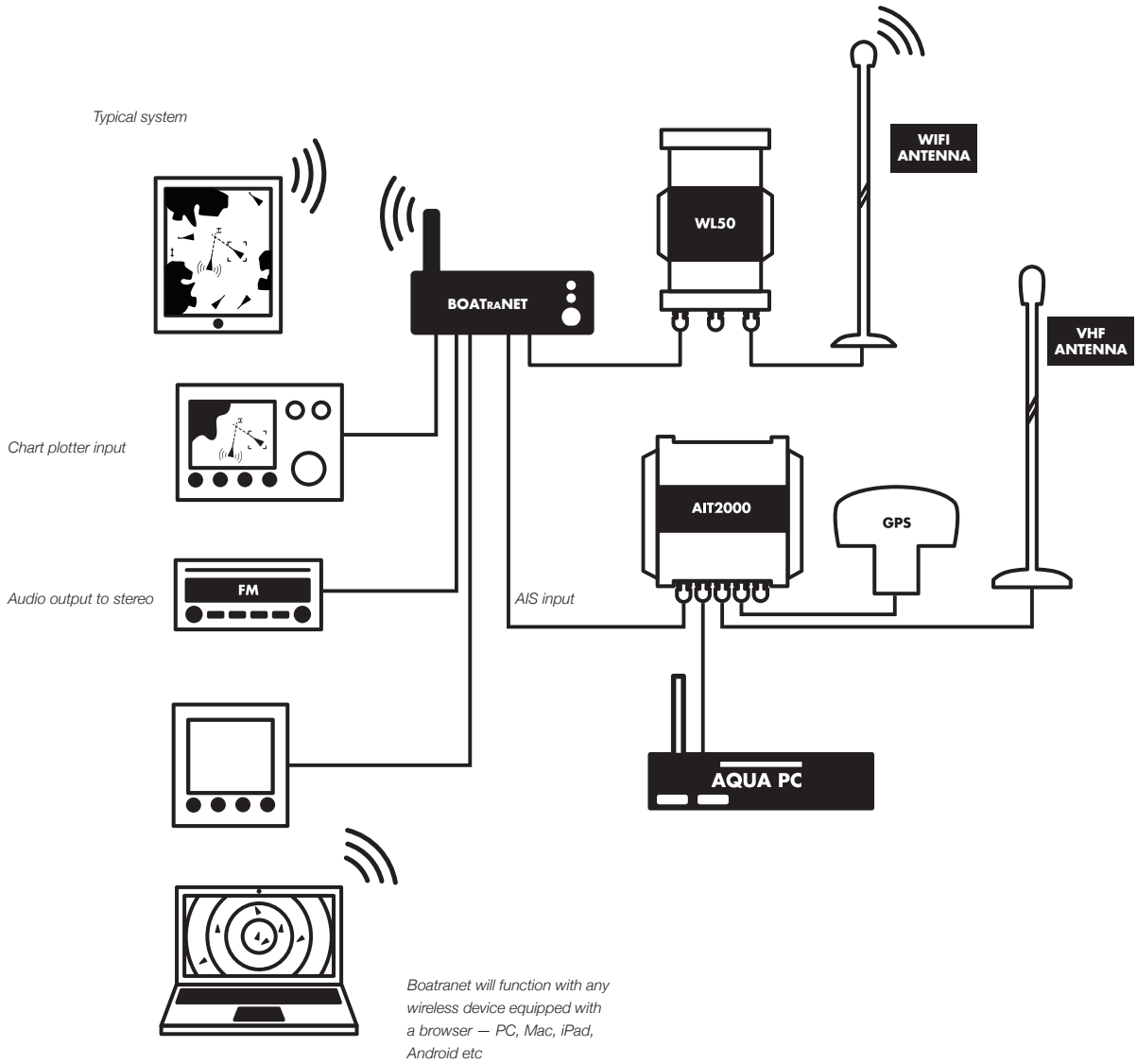

DIMENSIONS

295mm x 225mm x 62mm

(L x W x H)

SUPPLIED WITH

1m Power/IO cable, Mounting brackets, Wifi Antenna and User Manual

PART NUMBER

ZDIGBNET

ZDIGBNET-EU

ZDIGBNET-US

ZDIGBNET-CAN

ZDIGBNET-ROW

UPC

738435472511

081159830021

081159830038

081159830052

081159830045

PRICES

\$ 1049.95

\$ 1249.95

\$ 1249.95

\$ 1249.95

\$ 1249.95



WIRELESS



INTERFACE



INTERNET

AIS ACCESSORIES AND GPS ANTENNAS

ZDIGCELVG	CEL-VG COMBINATION VHF/GPS ANTENNA WITH SPLITTER	\$ 549.95
ZDIGCELCX4A	CEL-CX4A 1.26M GRP HIGH QUALITY AIS VHF ANTENNA	\$ 170.00
ZCELE179F	E179F DECK BASE FOR CX4/CEL VG ANTENNAS	\$ 60.00
ZCELN280F	N280F ADAPTOR FOR 1" MOUNTS - Allows CX4A and WL510 antenna to fit to standard 1" format deck and rail mounts	\$ 60.00
X500.391	MA800 GPS ANTENNA (FITS 1 X 14tpi MOUNT) FOR AIT250/1000/2000 SERIES TRANSPONDERS	\$ 110.00
ZCELR225F	R225F LOW PROFILE GPS ANTENNA WITH 7.5M CABLE	\$ 160.00

WL SERIES WIFI ANTENNAS ACCESSORIES

ZDIGWLEXT	POWERED USB EXTENSION CABLE (5M) FOR WL50/400	\$ 49.95
X400.073	10M CABLE KIT FOR WL510 (Supplied as standard)	\$ 150.00
X400.083	20M CABLE KIT FOR WL510	\$ 300.00
ZDIGWL500UP	WL500-510 UPGRADE KIT	\$ 499.95
ZCELE179F	E179F DECK BASE FOR CX4/CEL VG ANTENNAS (SUPPLIED AS STANDARD WITH WL510)	\$ 60.00
ZCELN280F	N280F ADAPTOR FOR 1" MOUNTS - Allows CX4A and WL510 antenna to fit to standard 1" format deck and rail mounts	\$ 60.00

AQUA PC ACCESSORIES AND UPGRADES

ZDIGKB05	USB WIRED COMPACT KEYBOARD WITH HUB	\$ 59.95
ZDIGKB20	USB RF WIRELESS KEYBOARD AND MOUSE	\$ 89.95
ZDIGUSBNMEA	USB-NMEA SERIAL ADAPTOR CABLE AND AIS S/W PACK	\$ 59.95
ZDIG128UP	128GB SOLID STATE HARD DRIVE UPGRADE FOR AQUA STD/NAV/PRO (FROM 64GB)	\$ 199.95
ZDLIDBT120	BLUETOOTH DONGLE (included with AquaMedia system)	\$ 39.95
ZDIGN2KM	NMEA 2000 MODULE	\$ 299.95
ZDIGNMUP	4 PORT NMEA INTERFACE FOR AQUAPRO	\$ 399.95
X500.088	RJ45 PANEL MOUNT CONNECTOR	\$ 14.00

WINDOWS UPGRADES

ZDIGWIN8PRO	WINDOWS 8 PRO	\$ 179.95
--------------------	---------------	-----------

DIGITAL DEEP SEA

DIGITAL DEEP SEA PRODUCTS ARE DESIGNED FOR THE PROFESSIONAL MARKET INCLUDING COMMERCIAL SHIPPING, FISHING, WORKBOAT, SUPER YACHT AND NAVAL APPLICATIONS. THEY'RE BUILT TOUGH FOR A DEMANDING ENVIRONMENT YET SHARE THE SAME INNOVATIVE DESIGNS AND GREAT VALUE OFFERED BY OUR LEISURE PRODUCTS. PRODUCTS SUCH AS OUR CLA1000 CLASS A AIS AND OUR AIS SART ALSO CARRY WHEELMARK IMO COMPLIANCE FOR MANDATED INSTALLATIONS. OUR AQUA PC PRODUCTS CAN ALSO FIND A PLACE ABOARD ANY COMMERCIAL INSTALLATION AND BRING PC BENEFITS TO THE HIGH SEAS.



SUPERYACHT

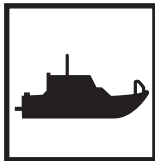

WORK BOAT



COMMERCIAL
FISHING

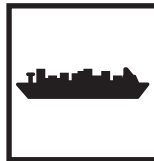

COMMERCIAL
SHIPPING



NAVAL

CLB2000 CLASS B TRANSPONDER

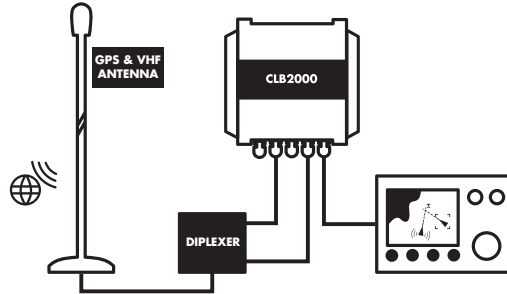

Typical system

“Class B AIS transponder for non-mandated vessels. The best solution for AIS with a combination GPS/VHF antenna”

KEY FEATURES

The CLB2000 uses the latest AIS Transponder technology to squeeze more performance and interfacing options in to a housing that is half the size of our previous generation transponder. This ultra-compact Class B Transponder has three outputs; NMEA 0183, NMEA 2000 and USB connection, allowing it to work with every AIS compatible chart plotter or software package on the market today.

Configuration of your vessel's fixed data, such as MMSI, call sign, boat name, dimensions etc. is made easy with the included Windows and Mac compatible proAIS2 software. Once configured, the unit will provide AIS data to a PC or Mac running suitable navigation software or a dedicated chart plotter, such as the latest Garmin, Raymarine, Navico and Furuno units.

The CLB2000 is supplied with an easy to install combination VHF+GPS antenna, that allows one RG58 cable to connect the 1.1m Antenna to the CLB2000, via a splitter that connects directly in to the CLB2000.

As well as transmitting your own vessel's position so that other AIS equipped vessels know where you are, the CLB2000, will receive all AIS targets within range of your boat – typically up to 30NM. Featuring a remote silence button option, two NMEA 0183 Inputs

and Outputs, four status LEDs and rugged vibration-proof mounting brackets, the CLB2000 is the perfect AIS transponder solution for all commercial vessels up to 300 tonnes that are not mandated to fit a Class A.

SPECIFICATIONS

- Latest generation AIS technology – featuring a brand new AIS transponder (Class B) design
- 12v and 24v Operation
- Ideal for use with existing plotter and radar systems
- Built-in high performance 50 channel GPS receiver (ideal also as a backup GPS)
- USB Interface for simple plug and play connection to a PC or Mac
- High speed NMEA output (38,400 baud) – compatible with industry standard plotters
- Supplied with a 1.1m ultra slim, combination VHF+GPS antenna complete with deck mounting and splitter box with connecting cables to CLB2000 – requires RG214 cable between Antenna and Splitter
- Remote silence function
- Supplied with programming software for user programming
- Easy to install black box solution with integral mounting brackets

The CLB2000 can also be supplied without the combination GPS-VHF antenna but with a GPS standard antenna. Price is the same as the AIT2000.

DIMENSIONS

150mm x 155mm x 37.5mm
(L x W x D)

PART NUMBER

ZDIGCLB2000
UPC
030955183725

SUPPLIED WITH

0.75m Power/Data cable, 0.75m
USB cable, 0.75m N2Net cable,
Combo GPS/VHF Antenna+Splitter

PRICE

\$ 1259.95



TRANSMITTER



AIS



USB



INTERFACE



INTERFACE



INTERFACE



MULTIPLEXER



GPS



WINDOWS 8



LINUX



MAC

CLA 1000 CLASS A TRANSPONDER

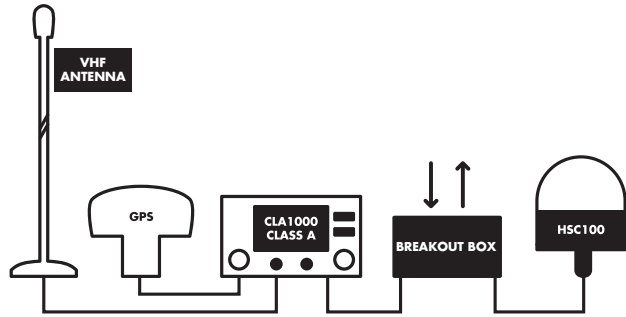

Typical system

“Fully IMO approved, Class A AIS transponder for certified installation on vessels over 300 GRT”

KEY FEATURES

The CLA1000 from Digital Deep Sea is a fully approved, Class A transponder that meets all IMO requirements. Built to the most demanding of standards, the CLA1000 is MED Wheel Marked and comes with a global 2 year warranty.

Normally fitted to larger vessels that are mandated to fit a Class A Transponder due to their size or number of passengers, many smaller non-mandated vessels can also benefit from fitting a Class A transponder. With 12W transmit power, compared to 2W for Class B, many off shore sail boats will benefit from being visible at greater ranges, whilst the faster (up to every 2 seconds) update rate of the Class A transmissions, compared to every 30 seconds with Class B, will definitely benefit larger power boats that can go a long distance in 30 seconds.

Two other important benefits of Class A Transponders are that they take priority over Class B transponders in areas of high AIS traffic (transmission slot allocation is guaranteed for Class A transponders) and they are always displayed on other Class A transponders and ECDIS systems on board large commercial vessels.

Hitting a new price point for Class A Transponders, the CLA1000 is now a realistic consideration for non-mandated vessels that would benefit from fitting a Class A transponder but could not justify the previously high price of this type of device.

SPECIFICATIONS

- Fully approved and MED Wheel Marked Class A Transponder
- Ultra Compact Design
- Easy soft key and rotary encoder operation
- Built-in GPS with easy to fit 1” x 14tpi mount GPS antenna
- Pilot Plug for easy PC connection
- Remote break out box for on-board interfacing
- Supplied with configuration software and SmarterTrack Lite AIS software

DIMENSIONS

195mm x 105mm x 157mm
(W x H x D)

PART NUMBER

ZDIGCLA
UPC
738435472573

SUPPLIED WITH

GPS Antenna, breakout box, trunnion bracket, flush mount kit, power lead and manual

PRICE

\$ 2799.95



TRANSMITTER



AIS



USB



INTERFACE



MULTIPLEXER



GPS



IMO APPROVED

PILOTLINK CLASS A AIS WI-FI INTERFACE

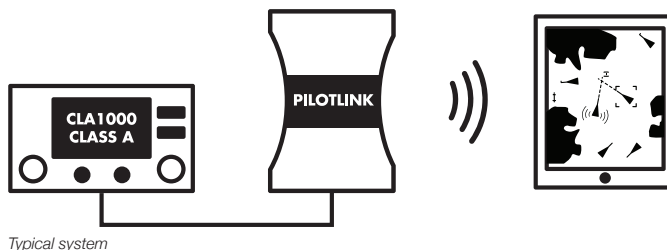

“Connects to the pilot plug interface so iPad, iPhones and other tablets can share the AIS data via a wifi link”

KEY FEATURES

PilotLINK is a wireless interface for Class A AIS systems. All Class A transponders share a common “Pilot Plug” connector that PilotLINK connects directly to via a 1m cable. PilotLINK then creates a wifi navigation network on board the vessel which allows AIS and GPS data from the Class A to be sent directly to any connected mobile devices such as phones or tablets. It’s compatible with iOS and Android systems (depending upon app utilised) as well as PC & MAC based systems.

PilotLINK is stand alone and can operate from its internal, user replaceable, dry battery (PP3) for up to 15 hours. Alternatively, it can connect via a standard mini USB connector to any USB style power pack or AC/DC USB power adaptor that are readily available from many 3rd parties.

PilotLINK is compatible with a wide variety of apps and PC programs. iAIS is a free of charge app from Digital DeepSea which gives a basic AIS radar type display and target information. It’s also compatible with iSailor and iNavX - both popular charting/ AIS products and many other 3rd party apps available through the Apple App store or Google Play on Android.

PilotLINK can also interface with a PC or MAC. Popular navigation programs such as SmarterTrack, SeaPro, RosePoint and MaxSea for PCs or macENC for a Mac are all compatible. PilotLINK ships with a complimentary copy of SmarterTrack Lite - a full featured AIS display program for Windows PCs.

SPECIFICATIONS

- Wireless Interface for Class A AIS Transponders
- Reads GPS and AIS data directly from the transponders Pilot Plug
- Supports bi-directional communication for configuring the transponder
- Uses standard NMEA data for maximum compatibility with software applications
- Free iAIS App for iPhone, iTouch or iPad
- Complimentary copy of SmarterTrack Lite for PCs
- Creates a wireless access point with a typical range of 30m
- Transmits data via TCP/UDP link
- TCP allows single device connection while UDP allows multiple devices to receive the data
- Fully compatible with many popular Apps and software programs
- Rugged handheld design can be fitted with optional rubber jacket
- Powered from internal 9v PP3 battery or optional external USB power source

DIMENSIONS

117mm x 70mm x 25mm
(L x W x D)

PART NUMBER

ZDIGPLINK
UPC
081159829988

SUPPLIED WITH

1m Pilot Plug cable, User Manual
and CD

PRICE

\$ 319.95



S1000 AIS SMART SART

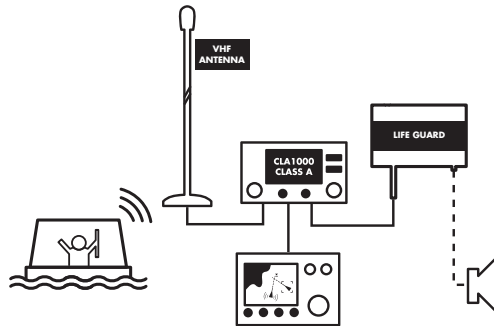

Typical system

“IMO Compliant AIS SART with the latest technology, performance and great value”

KEY FEATURES

A SART (Search and rescue transponder) is a mandatory fit for life saving apparatus on all vessels over 300GRT. Traditional technology used a radar type device, but new legislation allows an AIS SART to be used with associated performance and cost benefits. AIS SARTs positively identify the casualty and give a regular position update which can be graphically displayed on a Class A MKD, ECDIS or plotter.

The S1000 is a fully IMO compliant and approved AIS SART (Wheel Marked) which once activated, will display a target on any Class A or B transponder system or on an AIS receiver. As such it greatly aids recovery of the casualty or liferaft. SART alarms like our AIS Lifeguard are also activated by the signal from these devices.

The S1000 utilises specialist VHF antenna technology to offer exceptional range (typically up to 10NM) and has a battery life of 96 hours under operation. It comes with a storage bag and bracket mount and has a 1m telescopic pole integrated so it can be used in a liferaft. The integrated 50 channel GPS offers a very fast time to first fix (typically under 40 seconds) and thereafter position information is transmitted 8 times per minute. The SART

shows as a SART target on any AIS system and a safety message (SART ACTIVE) is sent every 4 minutes.

The S1000 SART also offers considerable safety benefits for leisure users and should be part of any safety pack for coastal or ocean sailing.

SPECIFICATIONS

- Full IMO Compliant, Wheel Marked AIS SART
- 50 channel GPS receiver built in
- Specialist VHF antenna technology for superior performance
- LED indications for test and activation
- When activated transmits position 8 times per minute
- 96 hour battery life
- Sends SART ACTIVE safety message every 4 minutes
- Easy to change, low cost battery replacement

DIMENSIONS

381mm x 67mm
(H x D)

PART NUMBER

ZDIGS1000

UPC

081159829995

SUPPLIED WITH

Supplied with mounting bracket,
U Bolts, 10m buoyant lanyard, 1m
pole mount and storage bag

PRICE

\$ 695.00



AIS



SAFETY

PILOT PLUG USB CABLE

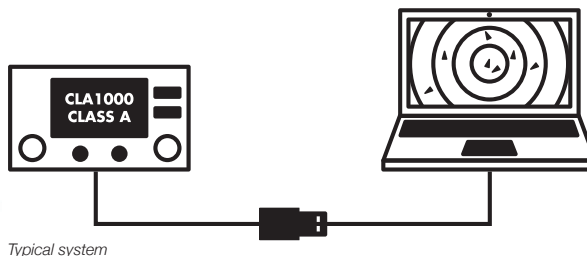
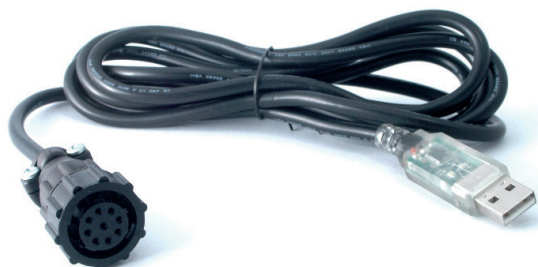

“Easy PC connections from a Class A AIS to a PC or MAC”

KEY FEATURES

All AIS Class A Transponders have a special “Pilot Plug” that is intended to allow a Commercial Pilot to quickly and reliably connect their laptop PC to the Class A Transponder when they arrive onboard.

The Digital Deep Sea Pilot Plug Cable, allows anyone to connect their PC to a Class A Transponder and receive NMEA0183 AIS and GPS data via a USB port. With some models of Class A transponders, this cable can also be used to configure the Class A with static AIS data and/or the mandatory voyage data that should always be programmed in to a Class A transponder before starting a passage.

The NMEA to USB Adaptor works on PCs, Macs and Linux computers, and converts NMEA 0183 data, used by many marine systems, into a USB format that can be plugged into most modern computers.

The adaptor is a bi-directional device so data can be sent to and from systems and has integral LEDs that flash as data is being received (green) and transmitted (red) which helps with interfacing issues. The Pilot Plug Cable creates a virtual COM port on the PC which

navigation and charting software can use to read NMEA data. The device ships with a multi platform driver CD so it can be used on PCs, MACs and even Linux based systems. If you’re using the device with a Windows PC, you’ll get a bonus as SmarterTrack Lite AIS viewing software is included on the CD - effectively turning your PC into an AIS target display.

SPECIFICATIONS

- 1.8m Cable
- Fully NMEA 0183 compatible (differential RS422)
- Conforms to the IMO SN/Circ.227
- Bidirectional data connection
- Low cost simple solution
- Built-in indicator lights flash to show data is being received and transmitted
- Easy plug and play connection to most computers (Windows/ Mac/LINUX)
- Comes with a driver CD and a free copy of SmarterTrack Lite AIS software

DIMENSIONS

1.8m cable

PART NUMBER

ZDIGPPL

UPC

030955183749

SUPPLIED WITH

1.8m Cable, Manual and CD

PRICE

\$ 160.00



AIS



USB



WINDOWS 8



LINUX



MAC

CLASS A PC PILOT PLUG EXTENSION CABLE



KEY FEATURES

All AIS Class A Transponders have a special "Pilot Plug" that is intended to allow a Commercial Pilot to quickly and reliably connect their laptop PC to the Class A Transponder when they arrive onboard.

Often on larger vessels the normal 1-2m length of the Pilot Plug can make connecting to the vessels Class A transponder difficult. As most Pilot Plug cables use a USB interface, which is limited to 5m, extending the cable can be problematic.

The Digital Yacht extension cable, extends the NMEA0183 wiring and not the USB wiring making it possible to extend up to 10m (or more) plus the length of the existing Pilot Plug cable.

SPECIFICATIONS

- 10m Cable
- Conforms to the IMO SN/Circ.227
- Can be used to extend any Pilot Plug
- Allows you to extend the cable without increasing the USB cable length which is limited to 5m

DIMENSIONS

10m cable

PART NUMBER

ZDIGPPLEXT

UPC

081159830182

SUPPLIED WITH

N/A

PRICE

\$ 140.00



AIS

DigAtoN

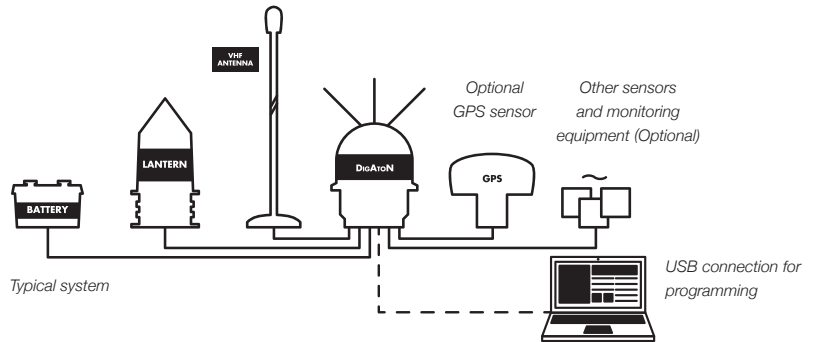

KEY FEATURES

DigAtoN AIS AtoNs fit to marine structures, hazards, buoys or can be configured to represent a virtual or synthetic point if mounted remotely from a physical location. AIS equipped vessels and shore stations can then not only identify the position of these marks but also read data (such as weather and instruments) collected by the AtoN. The DigAtoN is available as a Class 1 device (transmit only) or a Class 3 device (transmit and receive). Class 1 devices require a local AIS base station to be operating in the same area as the AtoN whereas Class 3 devices can internally allocate slots for transmission allowing them to be placed anywhere. Class 3 devices can also be configured and queried remotely and wirelessly “chained” together for extended range configuration. DigAtoN products are also available with an additional sensor interface installed to allow extended monitoring and digital switching capability.

SPECIFICATIONS

- Available as a Class 1 or Class 3 device
- Ultra tough and waterproof to IPX7
- Approved for global use
- Internal GPS sensor and antenna with external antenna option available with best in class power consumption (important for self powered structures)
- Class 3 devices support chaining and remote (VDL) configuration and monitoring

- Virtual and synthetic capability (up to 5)
- Adjustable transmit power (1 to 12.5W)
- Highly configurable for all AtoN applications with full range of interface solutions from Digital DeepSea
- Additional S models feature extended I/O capability –
 - Current sense
 - Three non-isolated analogue inputs and two isolated analogue inputs
 - 5 isolated digital I/Os and 5 non-isolated digital I/Os
 - Two RS232 ports and a fully isolated RS422/NMEA port
 - Two relay drive outputs
 - SDI-12 serial bus
 - Input voltage monitor (no external connection required)

APPLICATIONS

- Marking offshore structures, wind farms, wrecks, points of interest or danger areas
- Transfer of local meteorological conditions such as wind, pressure, wave height. Custom data transmission to base stations such as electrical status, tide, current, salinity etc measurements and localised tide and current information
- Use virtual or synthetic AtoN capability to mark 5 virtual points (ideal for yacht club racing or movable marks)

DESCRIPTION

ATN1000 CLASS 1 ATON
 ATN1000S CLASS 1 ATON WITH SENSOR INTERFACE
 ATN3000 CLASS 3 ATON
 ATN3000S CLASS 3 ATON WITH SENSOR INTERFACE

PART NUMBER

ZDIGATN1000
 ZDIGATN1000S
 ZDIGATN3000
 ZDIGATN3000S

UPC

081159830267
 081159830274
 081159830281
 081159830298

PRICES

\$ 5100.00
 \$ 5500.00
 \$ 6500.00
 \$ 6900.00



AIS



USB



INTERFACE



ATON CLASS 1



ATON CLASS 3



LOW POWER

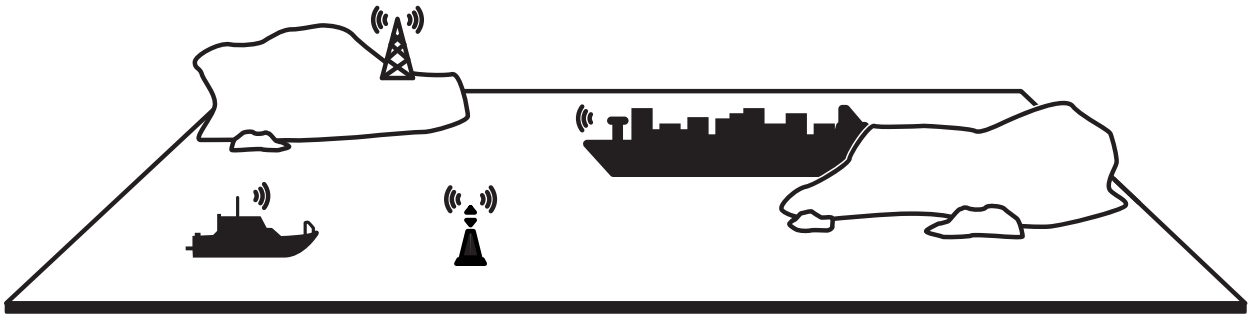

AIS AtoN application

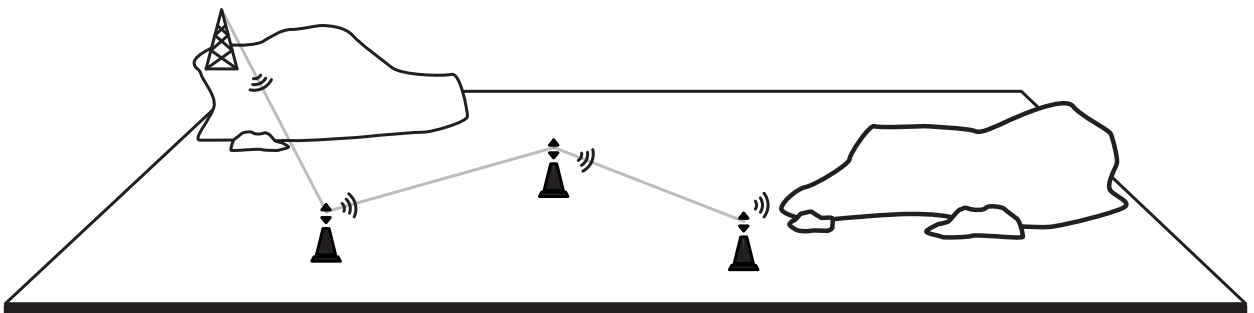

AtoN chaining

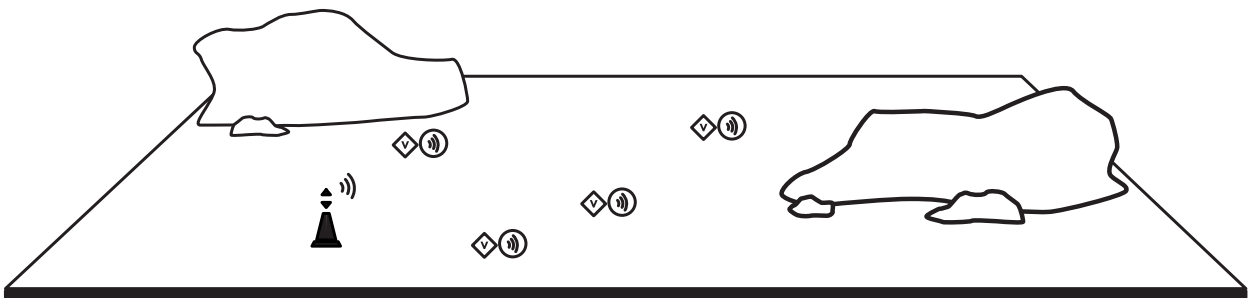

Virtual AtoN

SUPPLIED WITH

ZDIGATN1000 AIS DigAtoN Transceiver
 ZDIGATN3000 Mounting bracket and fixings
 Bird deterrent components
 Product manual and CD
 USB configuration cable
 Power and data cable

ZDIGATN1000S AIS DigAtoN Transceiver
 ZDIGATN3000S Mounting bracket and fixings
 Bird deterrent components
 Product manual and CD
 USB configuration cable
 Power and data cable
 Sensor Interface cables

DIMENSIONS

235mm x 188mm
 (H x W)

387mm x 188mm
 (H x W)





Tel: 978 277 1234
www.digitalyachtamerica.com
Edition 1 | 2015

Suite 1702
265 Franklin St
Boston
MA02110

Designed and manufactured in



Follow our daily news feed at www.digitalyacht.net