

DIGITAL
YACHT



SAIL BOAT



SPORT FISHING



MOTOR BOAT



PRODUCT GUIDE 2018

UK Market GBP / £ ex VAT

Tel: 01179 554 474

www.digitalyacht.co.uk

Edition 1 | 2018

DIGITAL YACHT 2018 IS ALL ABOUT NEXT GENERATION NAVIGATION, COMMUNICATION AND ENTERTAINMENT SYSTEMS FOR YOUR BOAT. BOATING SHOULD BE FUN, SAFE AND EASY AND OUR PRODUCTS INTEGRATE INTO EXISTING AND NEW BOAT NETWORKS TO BRING A POWERFUL DIMENSION TO YOUR ON-BOARD

We firmly believe that low cost consumer devices such as iPhones and tablets, PCs and MACs have a place on board and can help make legacy systems compete with the latest in dedicated marine electronic products at a fraction of the cost. We make internet access whilst afloat easy and affordable as well as bringing all your navigation data to your favourite consumer devices - not just for you but for crew and guests too.

Our navigation systems cover advanced GPS and compass technology as well as the most comprehensive range of AIS products in the marketplace. Plus our PC and software solutions bring simple yet powerful solutions to a variety of on board requirements from communication to navigation, entertainment to monitoring.

Our design team has 100's years combined experience in marine electronic systems and we take pride in our quality heritage with manufacturing in the UK and global reach with offices in the US and China. Last year our products were sold in over 100 countries worldwide.

Good Boating,



Nick Heyes

AIS100 RECEIVER (NMEA 0183)



Typical system

“Connects to any NMEA AIS compatible chart plotter and adds an AIS overlay. Simple to install, highly sensitive dual channel design that’s easy to install with Garmin, Raymarine, Standard, Lowrance, Simrad, Furuno etc plotters”

KEY FEATURES

This value priced, entry level AIS receiver is Digital Yacht’s most cost effective solution for adding AIS to your boat. Featuring the same dual channel receiver as the AIS100Pro, but without the USB interface and multiplexer, there is no compromise on performance and the AIS100 will out-perform all other, inferior, single channel receivers.

For use with existing AIS compatible chart plotters, such as the latest Garmin, Raymarine, Navico, Standard Horizon and Furuno units. Typical AIS reception range is 20 – 20 m for a mast top Antenna.

SPECIFICATIONS

- Low cost entry level AIS receiver
- High performance dual-channel AIS receiver for use with existing plotter and radar systems
- High speed NMEA output (38,400 baud)
- Requires VHF Antenna or dedicated AIS Antenna (available as optional accessory) or splitter
- Easy to install IP54 black box solution
- BNC Antenna connector

EXTRA APPLICATIONS

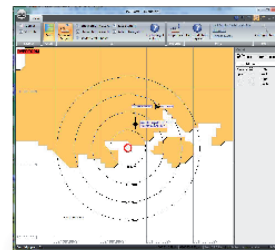

All Digital Yacht systems ship with SmarterTrack Lite PC software



Use the Qmax VHF Antenna— A small 25cm VHF Antenna with sucker cup mount. Ideal for portable use.

DIMENSIONS

105mm x 72mm x 32mm
(L x W x D)

PART NUMBER

ZDIGAIS100

UPC

738435472382

SUPPLIED WITH

Integral mounting brackets, 0.75m Power/Data cable, AIS Lite software on CD and User Manual

PRICE

£ 150.00



AIS



INTERFACE

AIS100 RECEIVER (USB)

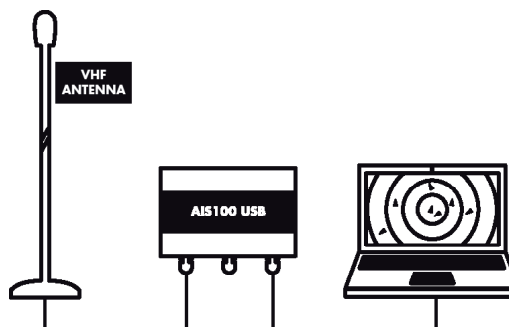

Typical system

“Perfect for PC based navigation systems with USB drivers for PC, MAC and linux”

KEY FEATURES

This value priced, entry level AIS receiver is Digital Yacht’s most cost effective solution for getting AIS on your PC. Featuring the same dual channel receiver as the AIS100Pro, but without the NMEA 0183 Output and multiplexer, there is no compromise on performance and the AIS100USB will out-perform all other, inferior, single channel receivers.

Simple plug and play USB connection to a PC. Uses standard drivers built-in to Windows XP/Vista/7 and is automatically mapped to an available “virtual” com port, which your PC software can read. Also compatible with Mac OS X and all LINUX Kernels since V2.4.20.

For use with any AIS compatible PC navigation software, such as the latest SmarterTrack, MaxSea, SeaPro, Nobeltec and Rose-Point applications.

SPECIFICATIONS

- Low cost entry level AIS receiver
- High performance dual-channel AIS receiver for use with AIS compatible PC navigation software
- USB Interface for simple Plug and Play connection to a PC
- Requires VHF / AIS Antenna or splitter
- Easy to install IP54 black box solution

EXTRA APPLICATIONS

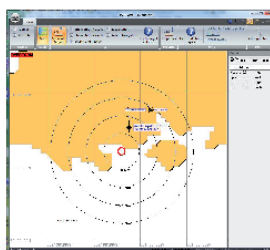

All Digital Yacht systems ship with SmarterTrack Lite PC software



Use the Qmax VHF Antenna— A small 25cm VHF Antenna with sucker cup mount. Ideal for portable use.

DIMENSIONS

105mm x 72mm x 32mm
(L x W x D)

PART NUMBER

ZDIGAIS100USB

UPC

738435472399

SUPPLIED WITH

Integral mounting brackets, 0.75m Power cable, 0.75m USB cable, AIS Lite software on CD and User Manual

PRICE

£ 150.00



AIS



USB



LINUX



MAC



Windows 10

AIS100PRO RECEIVER (NMEA & USB)

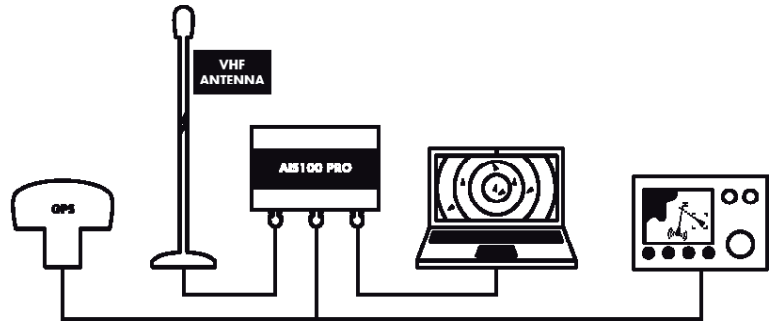

Typical system

“Combination NMEA and USB connections for PC and plotter based systems. Also features NMEA input and inbuilt multiplexer”

KEY FEATURES

Great entry-level AIS receiver for use with PC navigation software and chart plotters, such as the latest Garmin, Raymarine, Navico, Standard Horizon and Furuno units. Connected to an existing VHF Antenna (via a splitter) or dedicated AIS Antenna, you can receive all AIS targets within range – typically up to 30nm. Simple plug and play USB connection to a PC. Uses standard drivers built-in to Windows XP/Vista/7 and is automatically mapped to an available “virtual” com port, which your PC software can read. Also compatible with Mac OS X and all LINUX Kernels since V2.4.20.

The AIS100 Pro has a dual NMEA0183 and USB output capability, allowing you to supply AIS data to a PC (via USB) and a dedicated plotter (via NMEA) for larger installations.

Connect the NMEA (4800 baud) output of your GPS to the AIS100Pro and it will automatically multiplex (merge) the slower GPS data with the high speed AIS data and transmit everything on the high speed NMEA output (38,400 baud) - perfect for connection to a chart plotter with only one NMEA input.

SPECIFICATIONS

- High performance dual channel AIS receiver for use with existing plotter and radar systems
- USB Interface for simple plug 'n play connection to a PC
- High Speed NMEA output (38,400 baud)
- Requires VHF Antenna or dedicated AIS Antenna (available as optional accessory) or splitter
- Multiplexed NMEA input for single NMEA GPS+AIS data output at 38,400 baud
- Easy to install IP54 black box solution

EXTRA APPLICATIONS

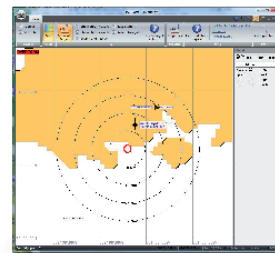

All Digital Yacht systems ship with SmarterTrack Lite PC software



Use the SPL2000 VHF – AIS Antenna splitter to share the vessels VHF Antenna with VHF and AIS.

DIMENSIONS

105mm x 72mm x 32mm
(L x W x D)

PART NUMBER

ZDIGAIS100P

UPC

030955183657

SUPPLIED WITH

Integral mounting brackets, 0.75m Power/Data cable, 0.75m USB cable, AIS Lite software on CD and User Manual

PRICE

£ 200.00



AIS



USB



INTERFACE



MULTIPLEXER



LINUX



MAC



Windows 10

AISNODE

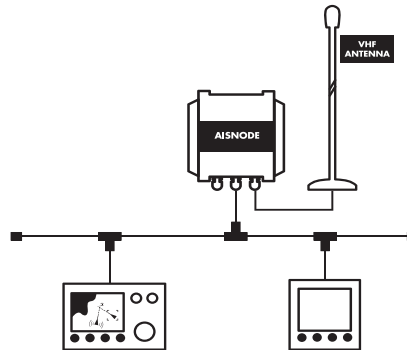

Typical system

“AISnode Brings Simple AIS Installation To NMEA2000 Networks”

KEY FEATURES

Many modern on board electronic system now utilise the NMEA2000 interfacing standard to allow inter-connectivity and interfacing between systems. It's an easy plug 'n play solution that allows reliable on board data sharing with simple common connectors. NMEA 2000 devices connect on a cabled “backbone” with a “T-connector” used to spur off to each device.

Digital Yacht have just introduced AISnode – an AIS receiver with an NMEA2000 interface allowing AIS data to – be shared across plotters, radars or other compatible devices on board. It's simple to fit too with power for this low wattage device taken direct from the NMEA2000 bus so there's no need for separate power supply. Just connect to a VHF Antenna or suitable VHF Antenna splitter (for a shared Antenna) and there's AIS data available for the plotter display. Once connected, you'll see an overlay of targets around you with drill down data on the vessels identity, position, course and speed as well as closest point of approach.

The new AISnode exploits Digital Yacht's sensitive dual channel receiver technology for excellent target reception range and ability to process all the latest types of AIS targets like ATONs and SARTs. Class A and Class B

targets are also fully decoded with all the relevant static and voyage data.

SPECIFICATIONS

- NMEA 2000 connectivity
- Self-powered from NMEA 2000 network
- Supplied with 1m NMEA 2000 cable
- High sensitivity dual channel design
- Decodes all the latest AIS target types including ATONs and SARTs

EXTRA APPLICATIONS



Add the NMEA2000 Starter Kit to have an NMEA2000 backbone on board

DIMENSIONS

160mm x 120mm
(L x W)

PART NUMBER

ZDIGAISNODE
UPC
081159830403

SUPPLIED WITH

Supplied with 0.8m NMEA 2000 drop cable

PRICE

£ 250.00



AIS



INTERFACE

iAIS RECEIVER



Typical system

“Award winning AIS receiver with wireless interface. Connect to your plotter, PC and mobile device through a wireless interface. Turns your iPhone or iPad into a full function AIS display and now also compatible with apps for Android too.”

KEY FEATURES

The world’s first wireless AIS receiver that links wirelessly with the latest iPhone, iPad and iTouch devices. Consisting of a high performance dual channel AIS receiver, an integrated 802.11b+g wireless access point plus a free app downloadable from the Apple App Store, the iAIS brings AIS data to a whole new generation of mobile devices.

iAIS also multiplexes any other NMEA data that is available on board the boat - for instance GPS, depth, speed and wind etc.

All of this data is combined with the AIS data into a single wireless feed, that becomes available on any compatible application. By using the boat’s own GPS, even an iTouch or iPad that does not have an internal GPS can now be used for navigation and superior performance will also be seen on an iPhone, which some users have complained suffers from jitter or poor lock-on with its internal GPS.

As well as sending data wirelessly, the iAIS also has an NMEA0183 and USB interface so that you can output data to a PC (via USB) and a dedicated plotter (via NMEA) for larger installations.

The free iAIS app is available from the App store and is a simple AIS display program. For more advanced use, Digital Yacht recommends the iNavX app (www.inavx.com). Now supports TCP/IP and UDP connection for multiple uses.

SPECIFICATIONS

- World’s first wireless AIS and NMEA Data server
- Tri-output; WiFi, NMEA 0183 and USB
- Multiplexed NMEA input for wireless NMEA data feed of boat’s instrument and GPS data
- TCP & UDP connectivity
- Free iAIS App for iPhone, iTouch or iPad
- Integrated 802.11b+g wireless access point
- Fully compatible with popular iNavX navigation application for Apple mobile devices
- Rugged IPX5 aluminium housing
- Requires VHF Antenna or dedicated AIS Antenna (available as optional accessory) or splitter
- Simple “fit and forget” black box solution

DIMENSIONS

150mm x 150mm x 37.5mm
(L x W x D)

PART NUMBER

ZDIGIAIS
UPC
738435472375

SUPPLIED WITH

Mounting brackets, 1m Power/Data cable, 1m USB Cable, iAIS app (from Apple App Store), software CD and User Manual

PRICE

£ 350.00



AIS



USB



INTERFACE



WIRELESS



MULTIPLEXER



Windows 10



LINUX



MAC



IOS



ANDROID

AISNET INTERNET BASE STATION



“Network enabled AIS receiver for base station operation. Simple RJ45 network interface and USB too. Perfect for use with Marine Traffic or AIS Live”

KEY FEATURES

AISnet is a new AIS base station receiver for use at home or in the office. Utilising the same high performance dual channel AIS receiver as the rest of the Digital Yacht range, AISnet also features an ethernet socket that can connect to a broadband router to send data to online AIS tracking services.

There are now a large number of internet based web sites, which offer a view of AIS equipped vessels on a background chart allowing users to check the position and identity of ships and yachts. If your home/office is close to the coast you can contribute your data to one of these sites, simply register with the company and they will give you an IP address and port number.

Using the setup program that Digital Yacht supply, it takes seconds to program the IP address and port into AISnet, which will immediately start sending your local AIS data seamlessly across the internet to be displayed on the site.

Data that AISnet is collecting, can also be viewed locally on your PC using

the free SmarterTrack Lite software. Plug the USB connector into your PC and AIS data will appear on your PC, whilst also transmitting over the internet.

AISnet is supplied with a universal UK/Euro/US mains adaptor that provides a regulated 12v supply from 240v/110v AC mains.

Contact us if you want the AISnet to be provided with a built-in VHF splitter.

SPECIFICATIONS

- AIS base station for home or office use
- Integrated ethernet network controller for supplying AIS data to online AIS websites
- High performance dual channel AIS receiver
- Simple configuration via free setup program
- USB Interface for simple plug and play connection to a local PC
- Requires VHF Antenna or dedicated AIS Antenna (available as optional accessory) or splitter
- Universal Mains power supply included
- Simple “fit and forget” black box solution

DIMENSIONS

244mm x 150mm x 60.5mm
(L x W x D)

PART NUMBER

ZDIGAISNET
UPC
738435472429

SUPPLIED WITH

UK/Euro/US mains adaptor, 1m USB Cable, AIS Lite + Setup software on CD and User Manual

PRICE

£ 325.00



AIS



USB



NETWORK



Windows 10



LINUX



MAC

AIT1500 CLASS B AIS TRANSPONDER

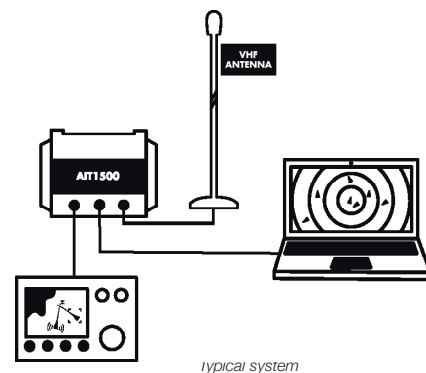

“An easy to install Class B AIS with built in GPS Antenna and universal NMEA 0183 interface”

KEY FEATURES

The regulations for AIS demand that the Class B transponder has to incorporate its own GPS positioning receiver which normally involves fitting an external Antenna. The AIT1500 incorporates a high sensitivity GPS Antenna within its compact case which saves on Antenna clutter and makes for a speedy installation. It's ideal for fitting on smaller vessels and tenders. It uses a NMEA0183 interface for simple connection to the vast majority of AIS compatible chart plotters and also has a separate 4800 baud GPS data output for the DSC VHF if required. It consumes less than 2W power and can operate on 12/24V systems. It also features a silence capability so the AIS transmissions can be muted while continuing to receive AIS traffic.

There is a USB interface for programming as well as for PC/MAC based navigation. It's compatible with Digital Yacht's NavLink MAC app and SmarterTrack PC navigation system

GPS signals will pass through plastic, glass and GRP so it will be able to be mounted below decks on many boats. A dedicated VHF Antenna is required for the AIS or a suitable VHF-AIS Antenna splitter such as the SPL2000. It can also connect to the WLN10 or AquaWear WLN20 wireless data gateway to feed data to a tablet or iPad

SPECIFICATIONS

- Advanced AIS design for the best performance
- Waterproof compact enclosure
- Built in internal GPS Antenna
- Dual NMEA 0183 outputs at 4800/38400 baud
- USB interface
- PC & MAC programming software included
- NMEA input multiplex function
- Silence switch option
- Supplied with programming and utilities CD

EXTRA APPLICATIONS



Use the SPL1500 – VHF Antenna splitter to share the vessels VHF Antenna with VHF and AIS.



Use the WLN10HS to send AIS targets on your navigation softwares & apps.

DIMENSIONS

120 x 160mm
(H x W)

PART NUMBER

ZDIGAIT1500
UPC
081159830366

SUPPLIED WITH

0.75M power and data cable, 0.75m USB cable and programming/utilities CD

PRICE

£ 420.00



TRANSMITTER



AIS



USB



INTERFACE



MULTIPLEXER



GPS



Windows 10



LINUX



MAC



ANDROID

AIT1500N2K CLASS B AIS TRANSPONDER

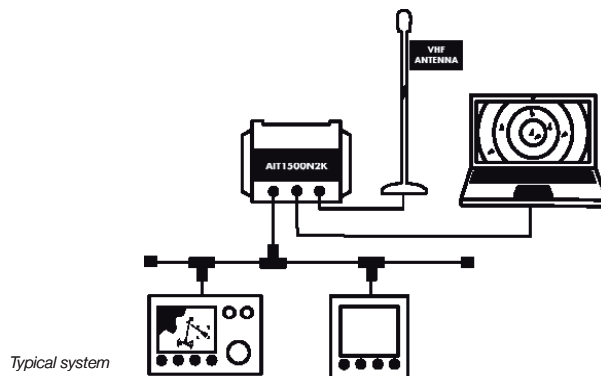

“An easy to install Class B AIS transponder with plug ‘n play NMEA 2000 interface and built in GPS Antenna”

KEY FEATURES

The regulations for AIS demand that the Class B transponder has to incorporate its own GPS positioning receiver which normally involves fitting an external Antenna. The AIT1500N2K incorporates a high sensitivity GPS Antenna within its compact case which saves on Antenna clutter and makes for a speedy installation. It’s ideal for fitting on smaller vessels and tenders. It has a NMEA2000 interface for simple connection to the majority of new AIS compatible chart plotters and includes an integral NMEA2000 drop cable with a male mini connector. It consumes less than 2W power and is self powered from the NMEA2000 network.

There is a USB interface for programming as well as for PC/MAC based navigation. It’s compatible with Digital Yacht’s NavLink MAC app and SmarterTrack PC navigation system

GPS signals will pass through plastic, glass and GRP so it will be able to be mounted below decks on many boats. A dedicated VHF Antenna is required for the AIS or a suitable VHF-AIS Antenna splitter such as the SPL2000. It can also connect to the NavLink wireless data gateway to feed data to a tablet or iPad

SPECIFICATIONS

- Advanced AIS design for the best performance
- Waterproof compact enclosure
- Built in internal GPS Antenna
- NMEA2000 interface with integral 0.75m drop cable
- USB interface
- PC & MAC programming software included
- Simple “plug and play” installation
- Takes its power from the NMEA2000 network
- Supplied with programming and utilities CD

EXTRA APPLICATIONS



Use the SPL1500 - VHF Antenna splitter to share the vessels VHF Antenna with VHF and AIS.

Add the NMEA2000 Starter Kit to have an NMEA2000 backbone on board.

DIMENSIONS

120 x 160mm
(H x W)

PART NUMBER

ZDIGAIT1500N2K

UPC

081159830519

SUPPLIED WITH

0.75M NMEA2000 cable, 0.75m USB cable and programming/utilities CD

PRICE

£ 450.00



TRANSMITTER



AIS



USB



INTERFACE



GPS



Windows 10



LINUX



MAC



ANDROID

AIT2000 CLASS B AIS TRANSPONDER

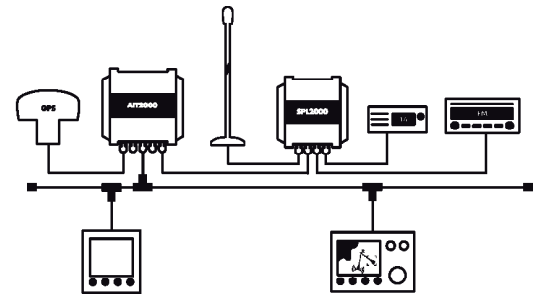

Typical system

“Great value, flexible AIS transponder solution with multiple outputs to suit every installation and optional wireless solution”

KEY FEATURES

The AIT2000 uses the latest AIS Transponder technology to squeeze more performance and interfacing options in to a housing that is half the size of our previous generation transponder.

This ultra-compact Class B Transponder has three outputs; NMEA 0183, NMEA 2000 and USB connection, allowing it to work with every AIS compatible chart plotter or software package on the market today. Featuring a remote silence button option, two NMEA 0183 Inputs and Outputs, four status LEDs and rugged vibration-proof mounting brackets.

Configuration of your vessel's fixed data, such as MMSI, call sign, boat name, dimensions etc. is made easy with the included Windows and Mac compatible proAIS2 software. Once configured, the unit will provide AIS data to a PC or Mac running suitable navigation software or a dedicated chart plotter, such as the latest Garmin, Raymarine, Navico, Standard Horizon and Furuno units. As well as transmitting your own vessel's position so that other AIS equipped vessels know where you are, the AIT2000, when connected to an existing VHF Antenna (via a splitter) or dedicated AIS Antenna, will receive all AIS targets within range of your boat – typically up to 30NM.

With two industry standard NMEA 0183 outputs, our own N2NET connector for plugging in to an NMEA 2000 network and a simple plug and play USB

connection to a PC, the AIT2000 is the perfect AIS transponder solution for all light marine vessels up to 300 tonnes.

SPECIFICATIONS

- Latest generation AIS technology – featuring a brand new AIS transponder (Class B) design
- USB Interface for simple plug and play connection to a PC or Mac
- Includes N2Net interface and cable for connection to NMEA 2000 network
- High speed NMEA output (38,400 baud) – compatible with industry standard plotters
- Comes complete with GPS Antenna with integral 1"x14TPI thread mount
- Requires VHF Antenna or dedicated AIS Antenna (available as optional accessory) or splitter (SPL2000)
- Remote Silence Switch option
- Easy to install black box solution

EXTRA APPLICATIONS



This AIT2000 + GV30 bundle is ideal for smaller boats and tenders, providing a single combination VHF+GPS antenna solution that makes installation easy and simple.
Part number of this bundle is: ZDIGAITBUN1

DIMENSIONS

150mm x 155mm x 37.5mm
(L x W x D)

PART NUMBER

ZDIGAIT2000

UPC

030955183626

SUPPLIED WITH

0.75m Power/Data cable, 0.75m USB cable, 0.75m N2Net cable, GPS Antenna, Programming software*

PRICE

£ 475.00

**Except US where dealer programming required*

TRANSMITTER	AIS	USB	INTERFACE	INTERFACE	MULTIPLEXER	INTERFACE	GPS	Windows 10	LINUX	MAC

AIT3000 NUCLEUS CLASS B AIS TRANSPONDER

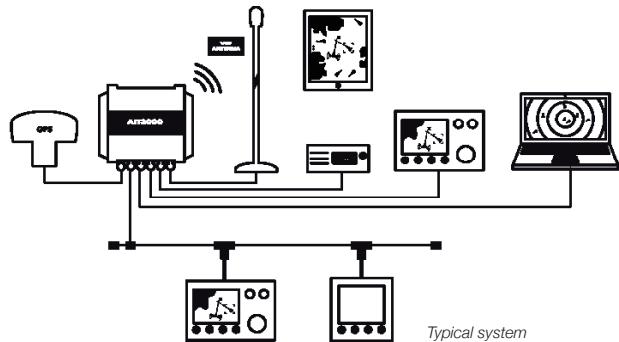

“The AIT3000 integrates a Class B AIS transponder with a ZeroLoss VHF-AIS splitter and full featured interface including NMEA0183, NMEA2000, USB and wireless making it easy and fast to install as well as offering maximum connectivity.”

KEY FEATURES

Class B AIS transponders have made a remarkable impact on small craft navigation but many potential users or installers are put off by the requirement for yet another VHF Antenna. The AIT3000 “Nucleus” Class B transponder changes this.

It incorporates not only a full function Class B AIS transponder but also an Antenna splitter allowing the main VHF Antenna on the boat to be shared with the AIS and VHF. It’s also been designed with the latest interfacing capability including NMEA 0183, NMEA 2000, USB and a WiFi server to integrate with tablets and iPads – hence the name Nucleus as it becomes the hub for on board navigation. NMEA 0183 data from other on board systems can also be multiplexed by the Nucleus and combined on the WiFi link. Nucleus brings a new level of connectivity and integration.

Today’s boat is all about connectivity - the Nucleus offers not only NMEA interfacing but USB for PC and MAC and WiFi for tablets and smartphones.

Digital Yacht has iAIS and NavLink apps for iOS and AISView for Android.

Configure the AIT3000 with the PC/Mac software ProAIS2 or with the free Android app AISConfig.

SPECIFICATIONS

- Combination Class B AIS transponder with patented ZeroLoss VHF-AIS Antenna splitter
- Full connectivity via
 - NMEA0183 Dual In/Out Interfaces
 - Built in multiplexer for instrument data
 - NMEA 2000 output
 - USB (PC and MAC)
 - Inbuilt WiFi server for tablets & smartphones
- Remote silence switch capability
- Ultra tough, waterproof and compact construction
- FM Antenna output
- Supplied with GPS Antenna
- Supported range of apps for iOS, Android, PC & MAC

SUPPLIED WITH

- | | |
|----------------------------------|---------------------------------|
| MA800 GPS Antenna | SmarterTrack Lite and proAIS2 |
| 3dBi WiFi Antenna | iAIS - Free download from Apple |
| 0.8m NMEA 2000 drop cable (male) | app store |
| 0.8m NMEA 0183 power-data cable | Mounting brackets |
| 0.8m USB cable | PL259 patch cable for VHF |
| Driver and software CD with | |

DIMENSIONS

220mm x 130mm

PART NUMBER

ZDIGAIT3000

UPC

081159830304

PRICE

£ 830.00

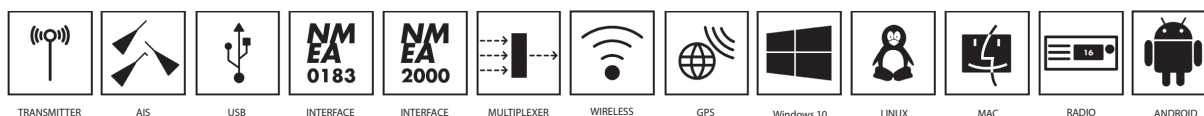

NOMAD PORTABLE CLASS B TRANSPONDER

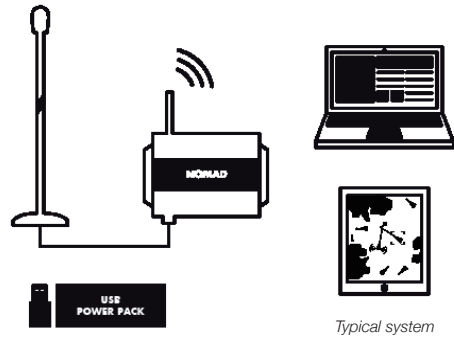

“The World’s first portable Class B transponder with a wireless interface”

KEY FEATURES

Nomad is a new, portable AIS navigation solution from Digital Yacht. Designed for recreational boaters and professional mariners, it offers a full function, Class B AIS transponder with a wireless and USB interface built in for tablets and PCs - all in a portable, compact package.

It addresses the needs of so many boaters who want a portable yet sophisticated navigation solution with AIS and GPS and the ability to interface with tablets, PCs and smart phones. It appeals to charter skippers, professional mariners like delivery skippers and pilots as well as boat owners who don’t want the hassle or cost of installing a dedicated transponder and like the concept of easy iPad and tablet navigation using their favourite charting apps with a detailed AIS overlay and real time GPS positioning. As a full function Class B transponder, it also sends you boat position to other AIS users.

It incorporates an innovative USB power solution allowing the Nomad to be powered from any standard USB source. This can include low cost, 3rd party battery packs, a USB PC connection or 12V USB adaptors/cigarette lighter adaptors. The GPS is built in and Nomad ships with a compact, 25cm external VHF Antenna with sucker cup mount. It can also connect to any regular VHF Antenna.

WiFi and USB interfaces are standard and there are a wide range of free and premium compatible apps for iOS, Android, PC and MAC. The wifi connection allows up to 7 tablets or iPads to connect.

Configure the Nomad with the PC/Mac software ProAIS2 or with the free Android app AISConfig.

SPECIFICATIONS

- Opens up new “portable navigation” market with the 1st portable Class B AIS transponder
- Applications include charter and delivery skippers, pilots, tenders and back up for main systems
- Can be utilised as AIS/GPS receive only
- Powered via USB – connect to PC, USB outlet or USB battery pack for power
- Wireless interface for iPad, tablet or PC/MAC
- Built in high performance GPS
- Supplied with portable VHF Antenna with sucker cup mount
- Can be used as AIS receiver only (if no MMSI programmed) or if silent mode selected
- Programmable via PC, Mac and app
- Choose your favourite charting and AIS app!

DIMENSIONS

120mm x 1350mm

PART NUMBER

ZDIGNMD
UPC
 081159830649

SUPPLIED WITH

Installation CD
 1m USB cable
 WiFi Antenna
 QMAX portable VHF Antenna

PRICE

£ 495.00



TRANSMITTER



AIS



USB



WIRELESS



GPS



Windows 10



LINUX



MAC

WHAT RANGE WILL I GET FROM NOMAD?

AIS uses VHF transmissions so range is limited to line of sight. With the compact Antenna you should be able to transmit up to 5NM and receive data from other vessels at 10-12NM. Shore stations would typically pick you up at 25NM. Connected to a mast top Antenna will give standard Class B ranges of up to 20NM as the power output (2W) is the same as all other Class B AIS

CAN I CONNECT A DIFFERENT VHF ANTENNA?

Yes you can. You may need a SO239 to BNC adaptor as Nomad uses a BNC Antenna connector. For best performance use an AIS tuned Antenna but a normal VHF Antenna will function

WHAT HAPPENS IF I DON'T HAVE A MMSI NUMBER OR HAVEN'T PROGRAMMED THE UNIT?

If the unit is unprogrammed, it will act as a receiver only outputting GPS and AIS data via WiFi and USB

HOW DO I VIEW AIS DATA?

Nomad has a USB interface (for power and data) that can connect to a PC or MAC. Any AIS compatible navigation software can be used and the PC will create a virtual com port. Digital Yacht offer free SmarterTrack Lite viewing software as well as premium SmarterTrack software for use with Navionics charts for detailed charting and navigation. It's also compatible with popular programs like MaxSea, Nobeltec, Expedition, SeaPro and Open CPN. Most modern programs accept a TCP/IP or UDP feed via the wireless link, but do double check before purchasing.

Apps on iPads, tablets and smartphones will use the wireless link to connect to Nomad. Check www.digitalyacht.net for iOS and Android apps as there are a huge number of popular charting and navigation programs

HOW DO I MOUNT NOMAD?

Most users will use a 3rd party mount like a mobile phone holder, RokLok, RailBlaza or RAM mount. The fixing holes also allow for a cable tie to be utilised and Nomad ships with two strips of high strength adhesive Velcro for a temporary solution. Nomad can also be permanently mounted using the screw holes provided onto a vertical bulkhead. It is important to mount Nomad vertically so that the internal GPS Antenna is facing the sky

CAN I USE THE QMAX ANTENNA WITH OTHER PRODUCTS?

The QMAX Antenna can be used as an emergency VHF Antenna. Remember it has a BNC connector so a BNC to PL259 adaptor may be required for a regular VHF

HOW MANY TABLETS CAN CONNECT TO NOMAD?

Up to 7 devices can connect wirelessly to Nomad at any time, which supports TCP (single device) and UDP (multiple devices) protocols



WHAT IS THE WIRELESS INTERFACE RANGE?

The wifi will typically footprint a boat up to 25m LOA. Contact us if you need a bigger footprint or have a steel or carbon vessel.

DOES NOMAD NEED AN INTERNET CONNECTION OR A GPS ENABLED TABLET?

The wifi will typically footprint a boat up to 25m LOA. Contact us if you need a bigger footprint or have a steel or carbon vessel.

CAN THE USB AND WIFI INTERFACED BE UTILISED CONCURRENTLY? OR A GPS ENABLED TABLET?

Yes

HOW DO I PROGRAM NOMAD WITH BOAT DETAILS?

proAIS2 programming software is provided for PC and MAC and AISConfig is a free downloadable Android app that allows programming via an Android device

GV30 AIS VHF GPS ANTENNA

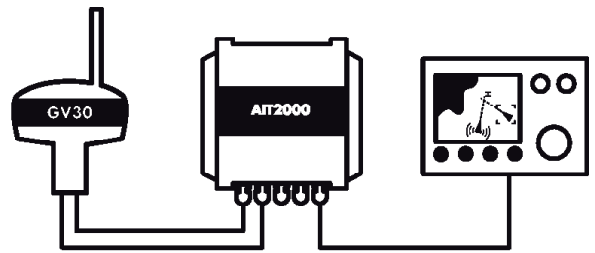

Typical system

“Combination AIS/VHF and GPS Antenna for Class B transponders which makes for a super quick and high performance installation”

KEY FEATURES

A Class B AIS transponder requires a dedicated GPS Antenna (all Class B units must have their own internal GPS and can't use an external feed for regulatory purposes) as well as a VHF Antenna or suitable VHF-AIS Antenna splitter. The GV30 is a combination VHF/AIS and GPS Antenna with twin coax feeds (10m). It's fitted with a standard 1" threaded base so will mount onto a variety of deck, pole and rail attachments available from many 3rd party suppliers.

The 10m coax cables are terminated with a FME mini connector which makes running the cable easy as the connector is barely bigger than the 5mm cable. We then supply suitable adaptors for the TNC and BNC connectors on our AIT2000.

The GV30 is just 190mm high and 75mm in diameter. Despite its compact dimensions, it offers very good performance as its specifically tuned to 162MHz (AIS frequency). The GV30 is also available with the AIT2000 as a bundle

SPECIFICATIONS

- Combination AIS/VHF and GPS Antenna
- Specifically tuned to 162MHz
- High gain GPS element
- Supplied with 2 x 10m cable tails fitted with mini connectors for easy cable installation
- Standard 1" threaded base for compatibility with a variety of 3rd party mounts
- Supplied with TNC (GPS) and BNC (AIS) adaptors
- Under 200mm high for low profile installation

DIMENSIONS

75MM X 190MM
(L x H)

PART NUMBER

ZDIGGV30
UPC
081159830076

SUPPLIED WITH

Supplied with user manual, 10m cables,
TNC adaptor and BNC adaptor
Note: not supplied with base

PRICE

£ 95.00



AIS



RADIO



GPS

SPL1500 VHF-AIS ANTENNA SPLITTER

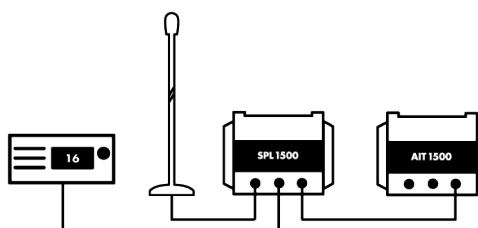

Typical system

“Patented zero loss technology lets you share your main VHF Antenna with both the VHF and AIS. Compatible with transponders and receivers.”

KEY FEATURES

An AIS receiver or transponder requires a VHF Antenna, but Digital Yacht’s new SPL1500 AIS-VHF Antenna splitter allows an existing Antenna to be used for both the AIS and VHF (DSC). Unlike most simple splitters, it can also be used with a class B transponder system and it incorporates special circuitry to ensure safe operation of the two transmitting devices.

The unit has three simple connections – one input for the main VHF Antenna and then outputs for the AIS receiver/transponder and another for the DSC VHF. It utilises Digital Yacht’s new, patented, ZeroLoss™ technology, to ensure the very best possible reception and transmission from all devices. Most importantly it is also fail safe, so should the unit ever stop working or lose power, it will not affect the main VHF operation. Until now, Digital Yacht, have recommended a dedicated Antenna for a receiver or transponder. However, with the new this new ZeroLoss™ technology, we can now offer a solution that greatly simplifies installation whilst maintaining performance.

The unit is waterproof and matches the aesthetics of the current AIT1500, so can easily be integrated into any vessel. It is suitable for operation on

12V or 24V systems and features three status LEDs that show the unit is powered correctly and when the AIS or VHF transmits.

SPECIFICATIONS

- Enables an existing VHF Antenna to be used for both the standard VHF and AIS system
- Patented ZeroLoss™ technology for exceptional performance
- Works with all Class B transponders and receivers
- Supplied with power cable, PL259-PL259 cable assembly and BNC-BNC cable assembly for easy installation (all cables 0.75m long)
- 12v or 24v Operation and low power consumption
- Fail safe operation
- Same size and design as the AIT1500
- Makes installation of an AIS receiver or transponder very quick and simple
- Saves on additional Antenna clutter

DIMENSIONS

150mm x 155mm x 37.5mm
(L x W x D)

PART NUMBER

ZDIGSPL1500

UPC

081159830687

SUPPLIED WITH

0.75m PL259 and BNC Coax interconnect cables, 0.75m power lead, integral fixing brackets and manual

PRICE

£ 195.00



AIS



RADIO

SPL2000 VHF-FM-AIS ANTENNA SPLITTER

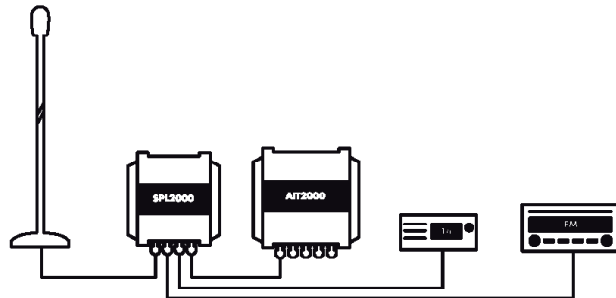

Typical system

“Patented zero loss technology lets you share your main VHF Antenna with the VHF radio, FM radio and AIS. Compatible with transponders and receivers.”

KEY FEATURES

An AIS receiver or transponder requires a VHF Antenna, but Digital Yacht’s new SPL2000 AIS-VHF Antenna splitter allows an existing Antenna to be used for both the AIS and VHF (DSC) and even with an AM/FM radio. Unlike most simple splitters, it can also be used with a class B transponder system and it incorporates special circuitry to ensure safe operation of the two transmitting devices.

The unit has four simple connections - one input for the main VHF Antenna and then outputs for the AIS receiver/transponder, DSC VHF as well as an optional car radio output. It utilises Digital Yacht’s new, patented, ZeroLoss™ technology, to ensure the very best possible reception and transmission from all devices. Most importantly it is also fail safe, so should the unit ever stop working or lose power, it will not affect the main VHF operation. Until now, Digital Yacht, have recommended a dedicated Antenna for a receiver or transponder. However, with the new this new ZeroLoss™ technology, we can now offer a solution that greatly simplifies installation whilst maintaining performance.

The unit is waterproof and matches the aesthetics of the current range of transponders and receivers, so can easily be integrated into any vessel. It

is suitable for operation on 12V or 24V systems and features three status LEDs that show the unit is powered correctly and when the AIS or VHF transmits.

SPECIFICATIONS

- Enables an existing VHF Antenna to be used for both the standard VHF and AIS system
- Patented ZeroLoss™ technology for exceptional performance
- Works with all Class B transponders and receivers
- Supplied with power cable, PL259-PL259 cable assembly and BNC-BNC cable assembly for easy installation (all cables 0.75m long)
- AM-FM radio Antenna connection for standard car stereo radio (integrated in power cable)
- 12v or 24v Operation and low power consumption
- Fail safe operation
- Same size and design as the new AIT2000
- Makes installation of an AIS receiver or transponder very quick and simple
- Saves on additional Antenna clutter

DIMENSIONS

150mm x 155mm x 37.5mm
(L x W x D)

PART NUMBER

ZDIGSPL2000

UPC

030955183756

SUPPLIED WITH

0.75m PL259 and BNC Coax interconnect cables, 0.75m power lead, integral fixing brackets and manual

PRICE

£ 215.00



AIS



RADIO

AIS LIFE GUARD (AIS MAN OVERBOARD ALARM)

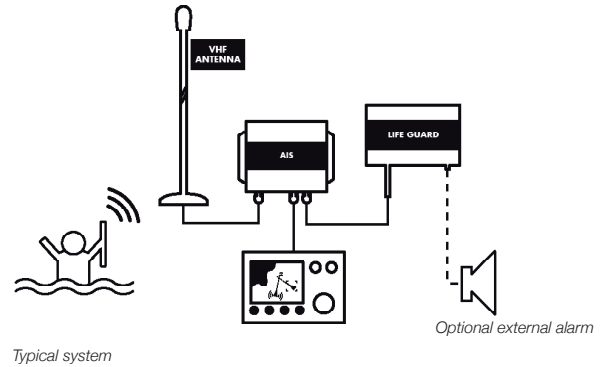

“AIS SART Alarm — Connects to any of our AIS devices and detects a SART target — ideal for use as a MOB system with personal SARTs”

All Digital Yacht AIS receivers and transponders are compatible with the AIS Life Guard and it is designed to operate on 12v or 24v DC systems.

KEY FEATURES

The AIS Life Guard is the world’s first AIS Man Overboard Alarm designed to work with the new generation of AIS SARTs that have recently been approved for global use by the IMO. Many existing AIS compatible chart plotters do not fully support AIS SARTs but with the AIS Life Guard connected to an AIS transponder or AIS receiver, you can have a complete working AIS SART man overboard system. Operation is automatic, simply connect the two wire NMEA input on the AIS Life Guard to the NMEA output of your AIS and it will listen to all AIS traffic.

As soon as an AIS SART transmission is detected the AIS Life Guard will sound its internal 95dB alarm and display a red warning light. For larger installations, it can also be connected to an external alarm (not supplied) so that the whole boat is immediately alerted.

The AIS Life Guard detects both message 1 and message 14, the two AIS messages reserved for AIS SARTs and will also give a short three beep alarm if it detects an AIS SART test message, great for checking correct operation of your AIS SARTs prior to a voyage.

SPECIFICATIONS

- World’s first dedicated AIS Man Overboard Alarm system
- Listens to AIS data on NMEA0183 Input
- Alarms when AIS SART message 1 and 14 are detected
- Internal 95dB buzzer with option to drive external alarm (not supplied)
- Audible and Visual Alarms
- Push button to silence alarm (short press) and reset alarm (long press)
- Easy to install IP54 black box solution

DIMENSIONS

150mm x 155mm x 37.5mm
(L x W x D)

PART NUMBER

ZDIGAISLG
UPC
30955183718

SUPPLIED WITH

0.75m Power/Data cable and User Manual

PRICE

£ 150.00



AIS



SAFETY



INTERFACE

	AIS100	AIS100USB	AIS100PRO	AISNODE	IAIS	AIT1500	AIT1500N2	AIT2000	AIT3000	NOMAD
KEY FEATURES	Entry level AIS receiver with NMEA0183 38400 baud output	Entry level AIS receiver with USB output for PC/MAC connection	Great entry-level AIS receiver for use with PC navigation software and chart plotters.	The perfect low cost entry level AIS Receiver for the new breed of small NMEA2000 chart plotters	Combination AIS receiver and NMEA multiplexer with Wi-Fi for mobile devices	Entry level AIS Transponder with industry standard NMEA0183 interface and internal GPS Antenna	An easy to install Class B AIS transponder with plug 'n play NMEA 2000 interface and a built-in GPS Antenna	An ultra-compact Class B Transponder with three outputs: NMEA0183, NMEA2000 and USB	A complete class B AIS transponder with VHF splitter and full connectivity: NMEA2000, NMEA0183, USB and Wi-Fi	The first portable class B AIS transponder with a wireless and USB interface built in for tablets and PCs
RECEIVE	•	•	•	•	•	•	•	•	•	•
TRANSMIT						•	•	•	•	•
RECEIVER FREQUENCY	161.975 MHz 162.025 MHz	161.975 MHz 162.025 MHz	161.975 MHz 162.025 MHz	161.975 MHz 162.025 MHz	161.975 MHz 162.025 MHz	161.975 MHz 162.025 MHz	161.975 MHz 162.025 MHz	161.975 MHz 162.025 MHz	161.975 MHz 162.025 MHz	161.975 MHz 162.025 MHz
NMEA0183 38400 OUTPUT	•		•		•	•		•	•	
USB OUTPUT		•	•	•	•	•	•	•	•	•
NMEA2000 OUTPUT				•			•	•	•	
WI-FI OUTPUT					•				•	•
NMEA INPUT MULTIPLEXER			•		•	•		•	•	
POWER REQUIREMENT	12/24V	12/24V	12/24V	NMEA2000 powered	12/24V	12/24V	NMEA2000 powered	12/24V	12/24V	USB powered
POWER DRAW	90mA	90mA	90mA	80mA	250mA	300mA	300mA	300mA	450mA	400mA
VHF SPLITTER									•	
ANTENNA CONNECTION	BNC (F)	BNC (F)	BNC (F)	BNC (F)	BNC (F)	BNC (F)	BNC (F)	BNC (F)	BNC (F)	BNC (F)
PROTECTION	IPX4	IPX4	IPX4	IPX5	IPX5	IPX5	IPX5	IPX5	IPX5	IPX5
DIMENSIONS (MM)	75x105x32 (HxWxD)	75x105x32 (HxWxD)	75x105x32 (HxWxD)	160x120x40 (HxWxD)	150x150x38 (HxWxD)	120x160 (HxW)	220x130 (LxH)	220x130 (LxH)	220x130 (LxH)	120x160x50 (LxWxD)

GPS150 DUALNAV™ GPS/GLONASS SENSOR

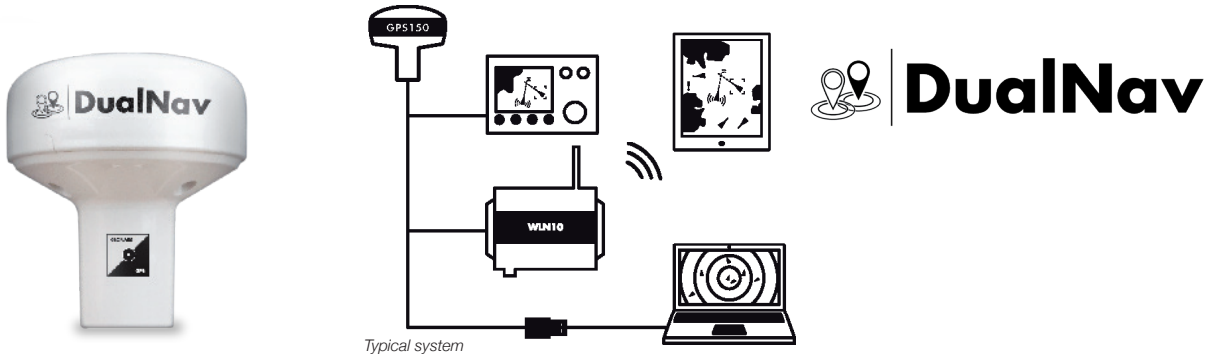

“DualNav technology offers unprecedented positioning accuracy with GPS and GLONASS compatibility and 10Hz super-fast NMEA position updates”

KEY FEATURES

The GPS150 DualNav™ positioning sensor combines a super accurate 50 channel GPS with GLONASS, the Russian funded satellite positioning system that is now on line and providing an excellent back up or alternative to GPS. This “smart” sensor will automatically switch between the systems or the user can manually select the most appropriate for their activity. In DualNav mode, a sophisticated algorithm combines GPS and GLONASS data to offer sub 1m accuracy. The GPS150 will also be able to utilise the European funded Galileo positioning system when it comes on line (IOC – Initial Operation Capability in 2018).

The implementation of GLONASS as an additional satellite positioning system is probably the biggest step change in maritime navigation since GPS was fully augmented back in the mid 90’s. Digital Yacht’s GPS150 utilises the industry standard NMEA data format allowing older chart plotters as well as current generation products to take advantage of this new technology.

The GPS150 also allows the user to select a variety of different NMEA baud rates (4800, 38400 and 115200) to allow interfacing with legacy and current systems. It also supports a new TurboNav™ mode which will appeal to racing yachtsmen and performance users where GPS/GLONASS data is output at 10Hz (10 x faster update than normal) and with an interface speed of 115200 baud which is 24 x the speed of normal NMEA data. This massively improves slow speed navigation data as well as providing the best course and speed data in a dynamic situation.

The GPS150 houses all the electronics in its compact 75mm Antenna and has a single multi core cable for power and data. Power consumption is just 30mA at 12V. It can be used as a simple positioning sensor for plotter

or VHF DSC systems as well as a precision, high speed sensor for performance sailing/super yachts. Setup is easy with a block of simple internal switches setting the characteristics of the unit. This allows the device to be programmed in the field without specialist software or programming tools.

The GPS150 can also connect to the WLN10 wireless interface to allow data to be sent to mobile devices such as iPhones, iPads and Tablets. There is also a USB interface for PC and MAC users (ZDIGUSBNMEA).

SPECIFICATIONS

- 50 channel precision GPS/GLONASS positioning sensor
- Just 75mm in diameter and designed to fit industry standard 1” mounts
- Ultra tough, waterproof construction
- NMEA output configurable for 4800, 38400 and 115200 baud
- Selectable update rates from 1 to 10Hz
- Configurable in the field using simple DIP switches inside the Antenna
- TurboNav mode offers super fast updates to optimise positioning information in slow and high speed applications
- WAAS/EGNOS/SBAS enabled for sub 1m accuracy
- User selectable GPS/GLONASS mode or auto selection
- Ultra low 30mA power consumption (at 12V DC)
- 5-30V DC power input

The installer can set the characteristics of the GPS150 such as mode, NMEA data output and update rate using a series of simple internal DIP switches - no complicated software to upload.

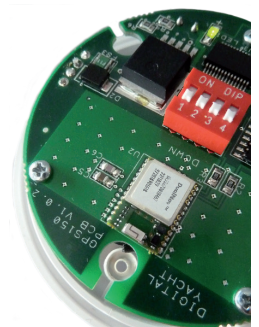



GPS AND NOW GLONASS

Knowing your position whilst at sea is key to safe navigation. What we now take for granted, was extremely difficult, time consuming and inaccurate. Then, in the latter half of the 20th century, came the electronic positioning systems – Decca, Loran, Transit and in the 1990s, the global positioning system, GPS. Over 20 years have passed since the first GPS receivers were commercially available and in this time the whole world has come to rely on this US funded technology. Now every boat, plane, car and train that we travel on has GPS navigation and even your smart phone can give a GPS position accurate to within 10m, anywhere in the world, at the touch of a button.

Much political discussion has taken place over our reliance on GPS technology, to the point where both Europe (Galileo) and China (Compass) are developing their own satellite based navigation systems, which are scheduled to be fully operational by 2020. However, whilst GPS was being developed in the 1980s, there was another competitive system developed in Russia called GLONASS. This system was very much overshadowed by the American GPS system and due to the secrecy surrounding the technology and the difficulties for non-Russian companies to license this technology, it never achieved wide spread commercial use outside of Russia and surrounding countries.

During Russia’s difficult financial period between 1989-1999, government spending on their space program was cut by 80% and launching of new GLONASS satellites stopped. With relatively short life spans the GLONASS satellites soon started to fail and by 2001 there were only 6 satellites still operational and the GLONASS service effectively ceased.

Most observers at the time thought this would be the death of GLONASS but in 2000, with the Russian economy recovering, President Vladimir Putin took a special interest in GLONASS and made the restoration of this service a high priority. Between 2002-2011, a large investment was made and at the end of 2011 GLONASS was fully restored and now offers worldwide coverage (with 24 operational satellites) and accuracy almost as good as GPS. In areas of high Latitudes (North and South) GLONASS is more accurate than GPS due to the orbital position of the satellites.

DUALNAV™ – NEW TECHNOLOGY

Now with the GPS150 DualNav™ technology, boat owners can have a single sensor that will automatically read satellite data from both GPS and GLONASS constellations, choosing the best signals from over 50 satellites. Wherever you are in the world you now have twice the satellites to choose from resulting in the GPS150 receiver having much better coverage, time to first fix and positional accuracy. Add to this the new high sensitivity receiver design, selectable baud rate and 10Hz position update rate and you have a GPS receiver that is significantly better than every previous marine GPS receiver on the market.

The new performance is particularly noticeable if the receiver is mounted below deck/inside the wheelhouse where the high sensitivity receiver still gives a good position fix or when there are obstructions blocking the view of the sky, such as a wet sail shadowing the Antenna or when sailing in rivers or close to cliffs, plus DualNav™ technology with more satellites to choose from, gives a much more accurate fix.

On larger boats, it is now possible to have two completely separate position sources, not just two GPS units but two different positioning systems so that you can compare and validate your actual position. Set one GPS150 to GPS mode and another GPS150 to GLONASS mode and you have dual redundancy and two independent positioning systems.

The GPS150 also supports SBAS (Satellite-Based Augmentation System) which is the generic name given to the differential signal transmitted by various local geo-stationary satellites. SBAS allows the GPS150 receiver to remove errors in the position due to environmental conditions and improves accuracy down to <1m. Using WAAS in the US and EGNOS in Europe the GPS150 will automatically switch to differential SBAS mode when available.

DIMENSIONS

75mm
(D)

PART NUMBER

ZDIGGPS150
UPC
081159830014

SUPPLIED WITH

Supplied with User manual and a 10m cable

PRICE

£ 125.00



INTERFACE



GPS



GLONASS



AUTO GNSS



MANUAL GNSS



10Hz UPDATE



TURBONAV

GPS150USB DUALNAV™ GPS/GLONASS SENSOR

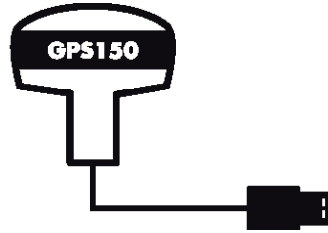

Typical system



“DualNav technology offers unprecedented positioning accuracy with GPS and GLONASS from this USB smart Antenna”

KEY FEATURES

The GPS150USB DualNav™ positioning sensor combines a super accurate 50 channel GPS with GLONASS, the Russian funded satellite positioning system that is now on line and providing an excellent back up or alternative to GPS. This “smart” sensor will automatically switch between the systems or the user can manually select the most appropriate for their activity. In DualNav mode, a sophisticated algorithm combines GPS and GLONASS data to offer sub 1m accuracy. It's designed to connect to a PC or MAC (an even LINUX system) via a USB connection. It also derives power via the USB cable so it's completely self contained an ideal for use on charter boats with a notebook PC charting system. The GPS150USB will also be able to utilise the European funded Galileo positioning system when it comes on line (IOC – Initial Operation Capability in 2018). Digital Yacht's GPS150USB utilises the industry standard NMEA data format and the USB connection creates a virtual COM port on the PC or MAC which is easily usable by all common marine charting programs such as MaxSea, SmarterTrack, SeaPro, Rosepoint, Nobeltec, Maptech, Expedition, Imray etc.

The GPS150USB also allows the user to select a variety of different NMEA baud rates (4800, 38400 and 115200) to allow interfacing with legacy and current PC systems. It also supports a new TurboNav™ mode which will

appeal to racing yachtsmen and performance users where GPS/GLONASS data is output at 10Hz (10 x faster update than normal) and with an interface speed of 115200 baud which is 24 x the speed of normal NMEA data. The GPS150USB houses all the electronics in its compact 75mm Antenna and has a single 5m USB cable for power and data. Power consumption is minimal via the USB connection. Setup is easy with a block of simple internal switches setting the characteristics of the unit. This allows the device to be programmed in the field without specialist software or programming tools.

SPECIFICATIONS

- Self-powered via 5m USB cable
- 50 channel precision GPS/GLONASS positioning sensor
- Works with all popular PC/MAC/LINUX charting programs
- Ultra tough, waterproof construction
- NMEA output (via USB) configurable for 4800, 38400 and 115200 baud
- Selectable update rates from 1 to 10Hz
- Configurable in the field using simple DIP switches inside the Antenna
- TurboNav mode offers super fast updates to optimise positioning information in slow and high speed applications
- WAAS/EGNOS/SBAS enabled for sub 1m accuracy
- User selectable GPS/GLONASS mode or auto selection

DIMENSIONS

75mm
(D)

PART NUMBER

ZDIGGPS150USB
UPC
081159830113

SUPPLIED WITH

Supplied with user manual, 5m cable and CD

PRICE

£ 165.00



GPS



GLONASS



AUTO GNSS



MANUAL GNSS



10Hz UPDATE



TURBONAV



USB

HSC100 COMPASS SENSOR

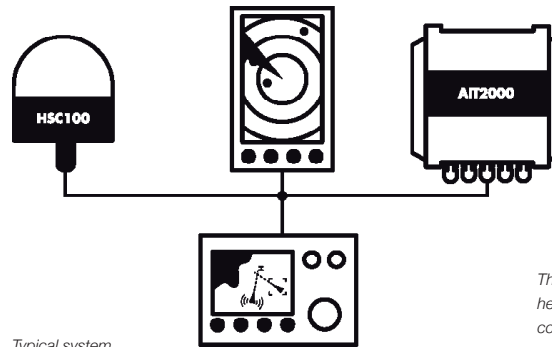

Typical system

The HSC100 will provide a 10Hz fast heading output for AIS, MARPA, radar course up/north up and chart plotter applications

“Fluxgate compass with auto calibration and fast heading output for MARPA or course up radar stabilisation”

KEY FEATURES

Accurate compass heading data remains a fundamental parameter for marine navigation and the HSC100 uses fluxgate technology to deliver heading data for on board systems. Typical applications include enabling course up and true motion type displays on chart plotters, radar overlay onto electronic charts and stabilisation of radars when used for MARPA/ARPA target tracking. Integrated instrument systems can also benefit from having compass information to calculate real time tidal set and drift when interfaced with a log and GPS.

Most low cost heading sensors only output data at 1Hz (once per second) but the HSC100 outputs at 10Hz which is required for MARPA target tracking and accurate radar overlays (Part # ZDIGHSC100).

We have also released a new “Rate of Turn” version of the HSC100 that outputs the HDT and ROT messages required by a Class A transponder. For non-mandatory vessels, this provides a simple low cost solution for adding heading and rate of turn to Class A transponders (Part # ZDIGHSC100T)

The HSC100 is waterproof (to IPx7) so can be mounted externally on

steel hulled vessels. It also features an automatic calibration routine to compensate for the effects of nearby magnetic influences. This involves turning the boat through 1.5 circles at a constant angular velocity whilst in calibration mode. Once completed, typical accuracies are within 0.5 degrees.

SPECIFICATIONS

- High Speed (10HZ) NMEA electronic fluxgate compass sensor
- Ideal for use with radar overlay and MARPA target tracking systems
- Industry standard NMEA 0183 “HDG” output
- Gimballed to 45°
- New “Rate of Turn” version of the HSC100 now released for Class A transponders (HSC100T)
- 12/24v DC operation with minimal power consumption
- Waterproof to IPx7 and suitable for external mounting on a steel hulled vessels
- Automatic calibration routine and manual compass offset feature
- Additional AD10 heading output for interface to Furuno systems
- LED Status Indicator
- 15m interconnect cable

DIMENSIONS

68mm x 30mm
(W x H)

PART NUMBER

ZDIGHSC100
ZDIGHSC100T

UPC

030955183688
030955183763

SUPPLIED WITH

15m Cable and manual

PRICE

£ 240.00



COMPASS



INTERFACE

WINDSENSE WIRELESS WIND SYSTEM

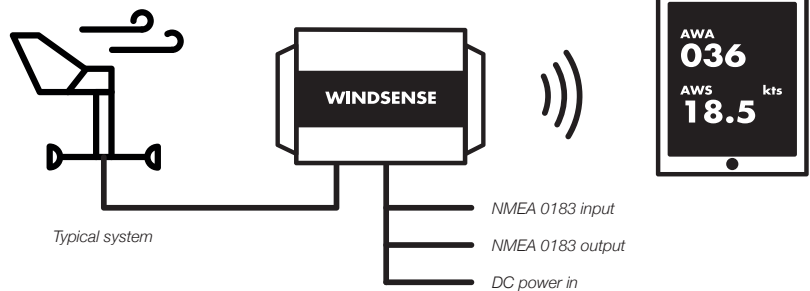

“Competitive, high performance wind system designed for use with iPads and tablets and with NMEA interface”

Installation is easy with an ultra-thin mast head unit cable with removable connector which plugs directly into the interface unit.

KEY FEATURES

WindSense is a new wireless wind system designed to allow iPads, tablets, SmartPhones and PCs to display accurate apparent wind speed and direction. It features a high quality, precision mast head sensor with 20m cable that connects to a below decks interface unit providing a wifi and NMEA 0183 wired connection. Existing NMEA compatible sensors can also be connected to the NMEA input to allow the wireless network to share other available on board instrument data. It's compatible with a wide range of apps for iOS and android. The built in wifi will typically footprint a GRP boat up to 30m

SPECIFICATIONS

- Stand alone or networkable (via NMEA 0183) wind system with precision mast head unit
- Wired connection with super-thin cable from MHU to below deck interface with wireless WiFi and wired NMEA connections
- Ultra tough Igildur mast head unit bearings for exceptional life and corrosion resistance
- Full range of apps for iOS & Android plus compatible with multiple PC and MAC apps
- Support for up to 7 WiFi connected devices – use multiple smart phones, iPads or tablets as a display at the helm, chart table or on deck
- NMEA 0183 output (\$MWW)
- NMEA 0183 (4800 or 38400 baud) input with multiplex facility for WiFi connection
- WiFi can be standalone or joined to existing network
- Minimal power consumption
- Optional NMEA 2000 interface

It has been attractively priced and positioned as a low cost replacement or addition to any marine electronics system but offers significantly enhanced accuracy, reliability and functionality with easy interfacing enabling a tablet to become a complete instrument display with other connected sensors. There are many vessels equipped with just a speed and depth system who require wind data too and also many older wind systems requiring replacement where customers do not want the substantial cost of a totally new instrument package. Depending upon the app utilised, true wind information, VMG and other sailing performance parameters may also be calculated.

DIMENSIONS

160 x 90mm
(W x D)

PART NUMBER

ZDIGWS
UPC
081159830625

SUPPLIED WITH

Masthead unit at 20m cable
WindSense Interface & WiFi Unit
NMEA/Power cable

PRICE

£ 375.00



INTERFACE



IOS



MAC



ANDROID



Windows 10



LINUX



WIRELESS



MULTIPLEXER



WIND

WLN10 WIRELESS NMEA SERVER (4800 BAUD)

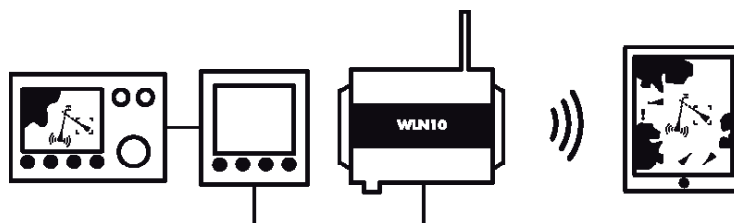

Typical system

“Create a wifi network on your boat with NMEA data available for iPhones, iPad or Android tablets — and PCs and MACS too. Turn you mobile device into a full featured navigator with access to all your boat’s NMEA data”

KEY FEATURES

This innovative and cost effective wireless device creates its own 802.11b+g wireless access point which any other wireless device can connect to, such as a Smart Phone, Netbook or Laptop. Connect it to any device or system that has an NMEA 0183 output and it will automatically read the data and transmit it wirelessly to another wireless device. The NMEA 0183 data is transferred using TCP/UDP protocol to a suitably compatible application on the wireless device.

A number of Marine Navigation software packages support TCP/UDP data transfer including;

- SmarterTrack (PC)
- SeaPro (PC)
- Rose Point Coastal Explorer (PC)
- MaxSea (PC) and Nobeltec (PC)
- MacENC (Macs)
- iNavX (iPhone/iPad)
- Nav Apps: iSailor and iRegatta

SPECIFICATIONS

- Wireless NMEA Data server (4800 baud)
- Reads NMEA 0183 data and transmits it wirelessly over 802.11b+g
- Can be fitted to any GPS or Instrument system that is outputting/inputting NMEA 0183 data at 4800 baud
- Supports Bi-Directional communication but must be at the same 4800 baud rate
- Creates an 802.11b+g wireless access point and then transmits data via TCP/UDP link
- TCP allows single device connection while UDP allows multiple devices to receive the data
- Fully compatible with popular iNavX navigation application for Apple mobile devices
- Easy to install IP54 black box solution

EXTRA APPLICATIONS



Visit the App Store to see the range.

DIMENSIONS

105mm x 72mm x 32mm
(L x W x D)

PART NUMBER

ZDIGWLN10
UPC
738435472580

SUPPLIED WITH

1m Power/Data cable, Wifi Antenna
and User Manual

PRICE

£ 180.00



WIRELESS



INTERFACE

WLN10HS WIRELESS NMEA SERVER (38400 BAUD)

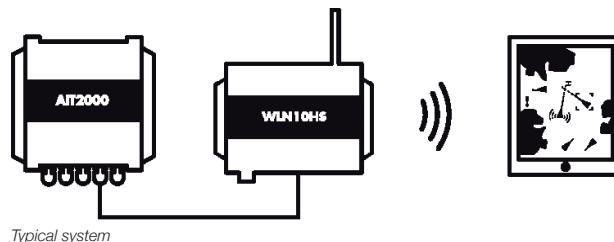

“Create a wifi network on your boat with NMEA data available for iPhones, iPad or Android tablets — and PCs and MACS too. Turn you mobile device into a full featured navigator with access to all your boat’s AIS data — the WLN10HS is preset to 38400 baud for AIS information”

KEY FEATURES

This innovative and cost effective wireless device creates its own 802.11b+g wireless access point which any other wireless device can connect to, such as a Smart Phone, Netbook or Laptop. Connect it to any device or system that has an NMEA 0183 output and it will automatically read the data and transmit it wirelessly to another wireless device. The NMEA 0183 data is transferred using TCP/UDP protocol to a suitably compatible application on the wireless device.

There are many apps which can overlay live AIS targets. If you are connecting the WLN10HS to an AIS receiver or transponder, then Digital Yacht’s free iAIS app is downloadable from the Apple App Store, which will display an AIS radar type picture on your Apple device. Or, download the app AISView if you have an Android device.

SPECIFICATIONS

- High Speed Wireless NMEA Data server
- (38400 baud)
- Reads NMEA 0183 data and transmits it wirelessly over 802.11b+g
- Can be fitted to an AIS unit or NMEA Multiplexer that is outputting/inputting NMEA 0183 data at 38400 baud
- Supports Bi-Directional communication but must be at the same 38400 baud rate
- Free iAIS App for iPhone, iTouch or iPad
- Creates an 802.11b+g wireless access point and then transmits data via TCP/UDP link
- TCP allows single device connection while UDP allows multiple devices to receive the data
- Fully compatible with popular iNavX navigation application for Apple mobile devices
- Easy to install IP54 black box solution

EXTRA APPLICATIONS



DIMENSIONS

105mm x 72mm x 32mm
(L x W x D)

PART NUMBER

ZDIGWLN10HS
UPC
738435472610

SUPPLIED WITH

1m Power/Data cable, Wifi Antenna and User Manual

PRICE

£ 180.00



WIRELESS



INTERFACE

AQUAWEAR WLN20 WIRELESS GATEWAY

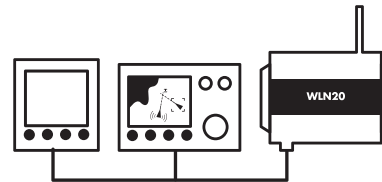

Typical system

“A wireless data gateway to connect smart phones and tablets system and introduces wearable navigation to the marine market with its stylish wrist case”

KEY FEATURES

The WLN20 is a wireless NMEA data server with two channel input. Stream real time NMEA information from your instrument, GPS and AIS systems to iPhones, smartphones, tablets and PCs. It ships with an AquaWear wrist case enabling next generation wearable navigation. Pop your smartphone into the supplied wrist case and start wearing your nav data on your sleeve. You'll benefit from using your accurate boat data and improve battery life on your smartphone as you'll not be reliant on its GPS and it will work below decks.

It's intuitive, easy and moves with you and of course allows you to choose from 1000's apps to suit your app! Digital Yacht have a range of compatible apps including NavLink and iAIS for iOS and AISView for Android. What's more it's interfaced using open NMEA 0183 standards so will work with any popular marine electronics system. Even legacy systems can connect bringing the latest apps to older systems.

It supports multiple devices and operating systems allowing all your crew to be connected. You can even stream data to a tablet, iPad or PC/MAC below decks. No connection to the internet is required as the WLN20 creates a local wifi hotspot on board your boat. Simply search for the

AquaWear wifi network on your device and connect and allow streaming boat NMEA data to be utilised by your device. The wireless network will typically footprint a GRP boat up to 25m in length. For large wooden and steel vessels please contact us and we can advise on installation techniques to ensure adequate coverage

SPECIFICATIONS

- Wireless data server for NMEA based systems
- Dual 4800/38400 baud NMEA 0183 inputs
- NMEA output from bi directional wireless interface supports more app features
- Compatible with 1000s apps
- AquaWear Alliance SDK available for new app developers
- Compatible with UDP and TCP/IP
- Support for up to 7 connected devices (UDP)
- Waterproof, compact and tough
- 12/24v low power operation
- Compatible with 1000s apps for iOS, Android, MAC and PC

DIMENSIONS

160 x 90mm
(L x W)

PART NUMBER

ZDIGWLN20
UPC
081159830311

SUPPLIED WITH

0.75m power/data cable

PRICE

£ 220.00



WIRELESS



INTERFACE



WEARABLE



MULTIPLEXER

NTN10 NMEA 0183 TO NETWORK GATEWAY



Typical system

“Overlay NMEA navigation data onto an existing network”

KEY FEATURES

Many large yachts now have an ethernet network installed at the build stage to allow easy installation of modern IT & communications products. The NTN10 allows NMEA 0183 navigation data to also be connected to the network, sharing the same cabling and allowing devices connected to the network to utilise this data.

On larger vessels, there will often be multiple wireless access points connected to the network and these can then also wirelessly transfer the data to connected devices like iPads and tablets.

The main reason for installing is to get navigation data from the vessels instruments, AIS or GPS onto the main network. It means connected devices like iPads or tablets then only have one network to select which can aggregate internet and navigation network data. Skippers can then use their iPad for navigation tasks using the main boat’s data. It also introduces the capability of an internet connected app for functionality such as live chart updates or weather overlays.

The NTN10 supports both TCP/IP and UDP data formats for maximum compatibility and can accept 4800 or 38400 baud NMEA data.

SPECIFICATIONS

- NMEA to network server
- Configurable for 4800 or 38400 format NMEA data and also compatible with MUX100 multiplexer
- UDP or TCP/IP server formats programmable by installer
- Simple RJ45 network connection
- Bi directional interface
- 12/24V installation

DIMENSIONS

150 x 244mm
(H x W)

PART NUMBER

ZDIGNTN10

UPC

081159830359

SUPPLIED WITH

0.75m NMEA cable, 1m RJ45 network cable

PRICE

£ 195.00



INTERFACE



NETWORK

IKOMMUNICATE UNIVERSAL INTERFACE

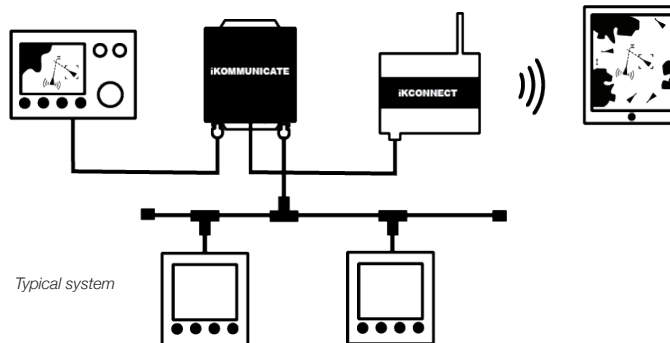

“The next generation universal interface for boats”

KEY FEATURES

iKommunicate from Digital Yacht is a radical new gateway designed to get NMEA 0183 and NMEA 2000 based marine electronic systems connected to the next generation of interfacing and the Internet of Things. It was developed via a successful Kickstarter crowd funded project back in early 2016 and is now available as a consumer product. It can also connect to a simple router like our iKConnect and provide a wireless feed of nav data to tablet based apps.

iKommunicate also acts as a NMEA to Signal K gateway. Signal K is an HTML5 “web ready” JSON based data format, that makes web and mobile app development really simple - even for amateurs. Apps can be written in minutes and data viewed in a browser. For instance, NMEA 2000 engine data such as fuel flow, temperature and pressure could be logged and then analysed for any trends indicating an engine service requirement. Internet integration is also easy with all sorts of social media possibilities using Twitter and Facebook for logging and tracking. iKommunicate can also act as a simple on board webserver so PDF manuals can be stored and viewed as required. Files can be stored on the integrated SD card reader.

iKommunicate features 3 NMEA 0183 interfaces and an NMEA 2000 interface so there’s plenty of connectivity. It has a built in webserver and ethernet port for easy connection to a wifi router so data can be shared with devices like tablets, Kindles, PCs and smart phones. NMEA data is

also made available on the ethernet port. There are already many apps that are compatible including NMEA Remote, iNavX, Active Captain, and Navionics (for sonar charts).

SPECIFICATIONS

- The World’s first NMEA to Signal K Gateway
- 12/24v DC Powered
- NMEA2000 Certified Gateway with Integral drop cable
- 3x Opto Isolated NMEA0183 Inputs and 2x Differential Outputs
- Signal K compatability for easy app development
- Comes pre-installed with some Signal K Web Apps
- Internal 8GB micro SD Card for hosting Web Pages and Apps
- Also provides wireless NMEA over TCP and UDP protocols
- Network Discovery via Bonjour (mDNS) and Windows SDDP
- 1 x RJ45 Ethernet (10/100Mb) network connection
- Easy setup with built-in Web Interface
- Easy to install black box solution

EXTRA APPLICATIONS



The bundle iKommunicate + iKConnect sends NMEA0183 & 2000 over Wi-Fi. Perfect combo to receive NMEA data on navigation softwares & apps.
Part number of this bundle is: ZIDIGKBUN

DIMENSIONS

135 x 120 x 50mm
(L x W x H)

PART NUMBER

ZDIGIK
UPC
081159830489

SUPPLIED WITH

0.75m NMEA2000 cable, 0.75m Power/Data Cable and 1m RJ45 network cable

PRICE

£ 220.00



INTERFACE



INTERFACE



INTERFACE



NETWORK

NMEA2000 STARTER KIT

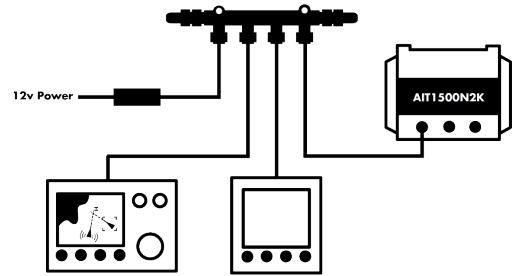

“A simple and low-cost NMEA 2000 starter kit which allows for up to 3 devices to interconnect.”

KEY FEATURES

NMEA 2000 is now the marine electronics industry’s de-facto standard for interconnection of devices. Using a simple “backbone” network structure, where each device is connected via a “drop cable”, the network must have terminators fitted at each end of the backbone and be separately powered. Specific NMEA2000 waterproof connectors are used throughout for maximum reliability and easy plug ‘n’ play installation.

Digital Yacht’s new NMEA 2000 starter kit is everything you need to create a small network on your boat, such as a chart plotter, AIS and autopilot. It includes a power cable, terminators, a 1m drop cable and a unique 6 way extension block that forms the backbone. Ports at each end accommodate the terminators or allow multiple starter kits to be joined together for a larger network.

Using high quality, nickel plated metal connectors rather than the cheaper plastic type, to improve reliability, the starter kit forms a really neat and compact installation, ideal for DIY installers or boat builders who want an easy and value priced solution for integrating and installing modern boat electronics

The connection system will work with all leading brands and can be

SPECIFICATIONS

- Everything you need in one box
- Smart 4-Way T-Piece “Backbone”
- 1m (3ft) Power Cable with in-line fuse
- 1m (3ft) “Drop Cable”
- Pair of removable network terminators
- Allows three devices to be connected
- Standard “Micro C” connectors make it very easy for future network expansion
- Metal connectors and reduced T-Piece connections improve reliability

DIMENSIONS

20.5cm x 11cm x 2cm
(L x W x D)

PART NUMBER

081159830670

SUPPLIED WITH

N2K backbone, 1m Power cable and
1m drop cable.

PRICE

£ 65.00



ST-NMEA SEATALK™ TO NMEA CONVERTER (OR USB)

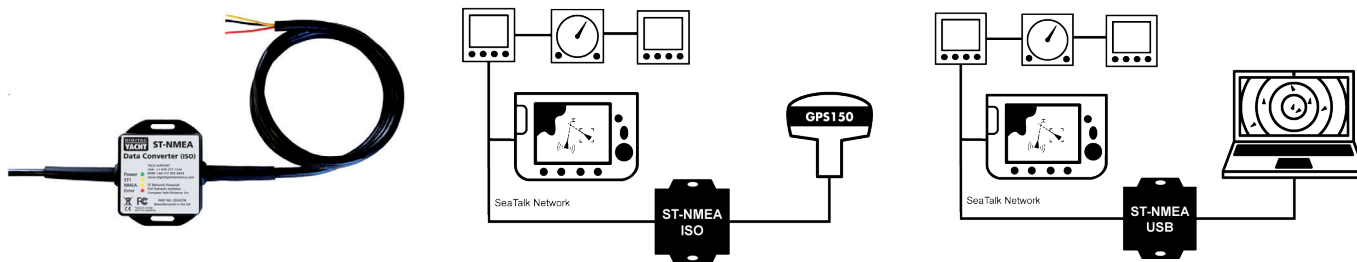

“The ideal data converter for any legacy Autohelm or Raymarine system. The USB version is also available to get SeaTalk™ data on to a computer”

KEY FEATURES

The SeaTalk™ interface, originally developed by Autohelm in the early 1990’s, was included on pretty much all Autohelm and Rarmarine (and some Raytheon) products up until about 2012. As a result there are thousands and thousands of boats around the world that have a SeaTalk 1 network and many owners, for one reason or another, need to convert from SeaTalk to NMEA0183 or many owners would like to get the SeaTalk data on to a PC, MAC or LINUX device.

Raymarine’s own SeaTalk to NMEA converter (E85001) is no longer available, and although some instruments/MFDs/autopilots have NMEA0183 interfaces, they do not always convert all of the data or are located in a difficult to wire to location.

Digital Yacht’s SeaTalk™ to NMEA (ISO) Converter is a small but powerful interface that provides bi-directional conversion between a SeaTalk network and an NMEA0183 network or device. Taking its power from the SeaTalk network, the ST-NMEA Converter features a full, multi-transistor SeaTalk 1 interface, an opto-isolated NMEA0183 input and differential NMEA0183 output that allows key navigational data to be reliably shared

between the SeaTalk and NMEA0183 networks. The USB version has a high speed USB 2.0 interface that allows key navigational data to be reliably shared between the SeaTalk network and applications running on the computer.

For developers and advanced users that want to access the raw SeaTalk data, the ST-NMEA converter can also be configured to work in a special “Raw Data” mode (\$STALK) which is gaining support in some Open Source projects.

The ST-NMEA (ISO) Converter is ideal for connection to one of Digital Yacht’s wireless NMEA servers, allowing SeaTalk owners to go wireless and a USB Version of the ST-NMEA Converter is also available for direct connection to a PC or Mac.

SPECIFICATIONS

- Small but powerful bi-directional converter
- Powered from the SeaTalk network
- Features reliable multi-stage transistor SeaTalk interface
- Opto-isolated NMEA0183 input and differential NMEA0183 output
- The USB version is compatible with all versions of Windows, OSX and LINUX
- Can be configured to operate in “Raw Data” mode (\$STALK)
- Converts all of the key navigational data

Note: SeaTalk™ is a registered trademark of Raymarine UK Limited

DIMENSIONS

170mm x 66mm x 15mm
(L x W x H)

PART NUMBER

ZDIGSTN
ZDIGSTNUSB

UPC

081159830700
081159830809

SUPPLIED WITH

0.75m SeaTalk1 cable, 0.75m
NMEA0183 or USB cable

PRICE

£ 125.00



INTERFACE



USB



INTERFACE

MUX100 NMEA MULTIPLEXER

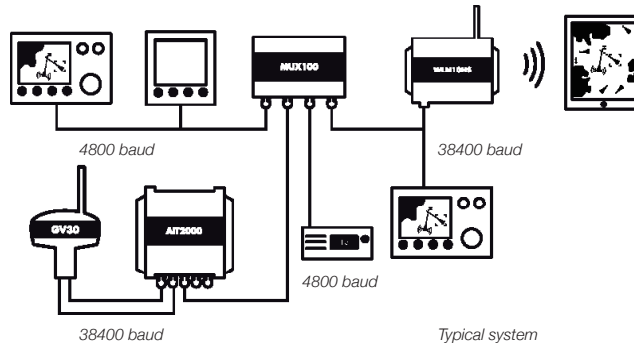

“The MUX100 multiplexer combines two channels of NMEA 0183 data and makes NMEA 0183 system integration and interfacing easy.”

KEY FEATURES

With modern AIS receivers and transponders outputting high speed NMEA0183 data at 38400 baud, it is often difficult to connect AIS data and low speed GPS or instrument data at 4800 baud to some chart plotters and/or PCs that have just one NMEA 0183 input. With the MUX100, all data received on the two input ports is multiplexed and transmitted on output 1 at 38400 baud. It is pre-configured so that Input 1 accepts AIS data at 38400 baud and input 2 accepts GPS/instrument data at 4800 baud.

Often low speed GPS data is required to give position information to a DSC VHF, but when an AIS transponder is fitted the GPS data is often only available at 38400 baud which will be ignored by the VHF. The MUX100 intelligently takes the GPS data from the AIS present on input 1 and re-transmits this on output 2 at 4800 baud – which can then be connected to the VHF. As a safety feature, should GPS data on input 1 be invalid or lost, the MUX100 will automatically switch to the GPS data on input 2 and transmit this on output 1 and output 2. To avoid duplicated data confusing other equipment, the MUX100 automatically blocks duplicated data on port 2.

Using intelligent priority switching, the MUX100 gives priority to input 1

but if GPS data is invalid or lost on input 1, it will automatically switch to input 2. When valid position data is received again on input 1, it will automatically revert.

Two LEDs on the face of the unit give indication of the data status, with a solid LED showing which port is currently providing GPS position and a flashing light on the other port to show that data is being received. If either LED is not lit or flashing it indicates no NMEA data present.

SPECIFICATIONS

- Dual input/output NMEA0183 multiplexer – simplifies NMEA integration and installation
- Accepts 38400 baud data on input 1 and 4800 baud data on input 2
- Combines all received data and transmits this data on output 1 at 38400 baud
- Extracts the GPS data from the high speed input 1 and re-transmits at low speed on output 2
- Important safety feature - gives priority to GPS on input 1 but switches to input 2 if position lost on input 1. Will switch back to input 1 when valid position fix data is received again
- Easy to install IP54 black box solution
- Opto isolated inputs and true NMEA differential output capable of driving several devices

DIMENSIONS

105mm x 72mm x 32mm
(L x W x D)

PART NUMBER

ZDIGMUX100

UPC

081159830120

SUPPLIED WITH

Integral mounting brackets, 0.75m
Power/Data cable and User Manual

PRICE

£ 100.00



MULTIPLEXER



INTERFACE

4G CONNECT

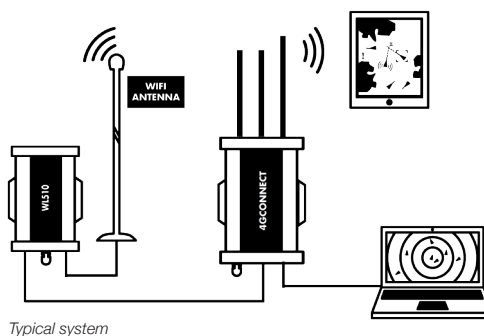

“4G Connect is a new 2G/3G/4G (LTE) internet access solution for use afloat. It utilises the latest MIMO technology with dual Antennas for fast, long range access and incorporates a full function wifi router”

KEY FEATURES

4G Connect is a new 2G/3G/4G (LTE) internet access solution for use afloat. It utilises the latest MIMO technology with dual Antennas for fast, long range access and incorporates a full function wifi router so multiple devices can connect wirelessly. There is also a wired LAN port and WAN port – for connection to high power wifi devices or satellite modems.

The Standard model has built in Antennas which are fine on most fibre-glass (GRP) hulled boats and will provide good performance when in port and close to shore. For carbon fibre, wooden or metal hulled vessels, or for boat owners that want the maximum possible range, we would recommend our 4GConnect Pro model with external high gain antennas (see next page).

4G Connect has an easy to use interface and it is SIM unlocked so users are free to use any cellular provider they choose. Users in Europe are recommended to utilise a Vodafone SIM as this provides excellent maritime performance.

Operation is simple – turn on, connect to the password protected wifi

hotspot that 4G Connect creates and your device is online. Digital Yacht’s WL510 high power wifi solution can also be connected to the WAN port for a choice between hotspot wifi and 4G connectivity. iKommunicate can also connect to the LAN port providing boat NMEA data on the wifi network for use with navigation apps.

SPECIFICATIONS

- Hi performance 4G/LTE modem for exceptional speed and range with fall back to 2G/3G
- SIM unlocked for any network provider
- Internal Antenna solution with MIMO technology
- LTE Class 3 modem offers long range and up to 70Mbps speeds
- Wifi interface for tablets and phones
- Offers good performance in port on GRP boats
- Ethernet LAN port for connection to iKommunicate navigation interface – allows boat NMEA 0183/2000 data to be available on the wifi network – ideal for smartphone and tablet navigation
- Ethernet WAN port can connect to satellite or WL510 high power wifi system for combination LTE/WiFi hotspot solution
- 12V DC operation with <5W power consumption
- Easy installation
- Easily upgradable to PRO with purchase of external Antennas and cabling

DIMENSIONS

380mm x 125mm x 55mm
(L x W x H)

PART NUMBER

ZDIG4GC

UPC

081159830748

SUPPLIED WITH

1m power cable, modem/router, 2
internal Antennas

PRICE

£ 299.00



INTERNET



WIRELESS



NETWORK



INTERNET



Windows 10



LINUX



MAC

4G CONNECT PRO

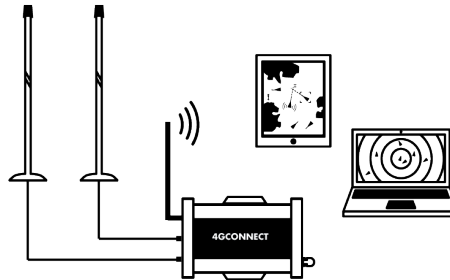

Typical system

“The Pro model uses two external Antennas for optimum speed and range and also incorporates a full function wifi router.”

KEY FEATURES

4G Connect is a new 2G/3G/4G (LTE) internet access solution for use afloat. It utilises the latest MIMO technology with dual Antennas for fast, long range access and incorporates a full function wifi router so multiple devices can connect wirelessly. There is also a wired LAN port and WAN port – for connection to high power wifi devices or satellite modems.

The Pro model ships with two external hi gain Antennas for exceptional long range performance and is the recommended solution for carbon fibre, wooden or metal hulled vessels and for those boat owners that want maximum range in all situations.

4G Connect has an easy to use interface and it is SIM unlocked so users are free to use any cellular provider they choose. Users in Europe are recommended to utilise a Vodafone SIM as this provides excellent maritime performance.

Operation is simple – turn on, connect to the password protected wifi hotspot that 4G Connect creates and your device is online. Digital Yacht’s WL510 high power wifi solution can also be connected to the WAN port

for a choice between hotspot wifi and 4G connectivity. iKommunicate can also connect to the LAN port providing boat NMEA data on the wifi network for use with navigation apps.

The 4G Connect Pro is provided with 7m cable kit so if you need 10m or

SPECIFICATIONS

- Hi performance 4G/LTE modem for exceptional speed and range with fall back to 2G/3G
- SIM unlocked for any network provider
- Supplied with 2 x high performance external 48cm Antennas for optimum speed and range
- 7m low loss LMR 200 cable kit included
- Supplied with deck base for Antennas (as shown)
- LTE Class 3 modem offers long range and up to 70Mbps speeds
- Recommended solution for offshore use and non GRP vessels
- Wifi interface for tablets and phones
- Ethernet LAN port for connection to iKommunicate navigation interface – allows boat NMEA 0183/2000 data to be available on the wifi network – ideal for smartphone and tablet navigation
- Ethernet WAN port can connect to satellite or WL510 high power wifi system for combination LTE/Wifi hotspot solution
- 12V DC operation with <5W power consumption
- Optional 1” base adaptor available for Antennas
- Optional 10 & 20m LMR400 assemblies

DIMENSIONS

380mm x 125mm x 55mm
(L x W x H)
Antenna: 480mm (H)

PART NUMBER

ZDIG4GCPRO
UPC
081159830755

SUPPLIED WITH

7m LRM200 cables, 2 mounting support,
2 external antennas, 1m power cable,
router/modem

PRICE

£ 499.00



INTERNET



WIRELESS



NETWORK



INTERNET



Windows 10



LINUX



MAC

WL510 HI-POWER WI-FI SYSTEM

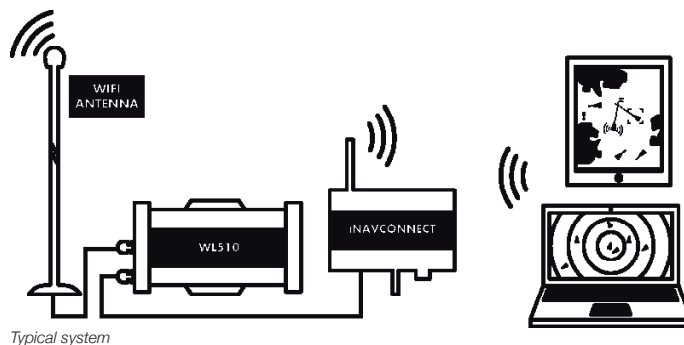

“Flagship hi power wifi connection system with ranges of 4-6NM. Features network interface for router compatibility and easy direct connection with browser interface”

KEY FEATURES

The new WL510 allows boat owners to connect to Wi-Fi hot spots so that their on board PC's or equipment can connect to the internet. With internet connectivity on board you can download the latest weather or chart updates as well as having a mobile office on board. Most harbours and ports have either free or subscription based services available.

The system has a compact, DC powered below deck mounted 600mW booster/modem and external, hi-gain (12dBm) Antenna with 10m (33ft) low loss LMR400 coax interconnect cable. The Antenna measures 0.9m (2.95ft) and can be supplied with deck, mast and industry standard 1" x 14TPI mountings.

The WL510 modem connects to an on board PC through a regular RJ45 CAT5 network cable for simple driver free installation. Connect the WL510 to a router and everyone on board can share the long range wireless internet connection. Compatible with all popular operating systems; Windows XP/Vista/7, Mac OS X 10.3 (and higher) and LINUX, the WL510 supports 802.11b/g protocols as well as WEP/WPA/WPA2 encryption. Wi-Fi range depends on many local factors, but Digital Yacht has seen

ranges of up to 4-6 miles with this low cost system. In general, using an internal Wi-Fi adaptor typically found on a notebook, you'll be lucky to find the signal at the end of the dock, so if you plan to access the internet whilst on board, the WL510 could be the solution for you.

SPECIFICATIONS

- Ideal solution for permanent installation and new builds
- Network Interface for connection to one PC or to a Router for shared long range connection
- Easy to setup and control from any browser through web based interface
- Adjustable (up to 600mW) Wi-Fi modem and high gain (12dBm) omnidirectional Antenna gives ERP up to 4W
- Supplied with threaded deck mount for Antenna and 10m of low loss LMR400 coax cable
- Supplied with 1m network cable - can be extended with any CAT5 network cable (up to 50m)
- Requires connection to boats 12v DC supply
- No drivers – works with all popular operating systems; Windows XP/ Vista/7/8, Mac OS X and LINUX compatible

Optional WL510-20 unit available with 20m cable.

DIMENSIONS

170mm x 107mm x 55mm
(L x W x H)
Antenna: 895mm (H)

PART NUMBER

ZDIGWL510
UPC
738435472603

SUPPLIED WITH

1m network cable, 10m Coax Cable, Antenna, Base Mount and User Manual

PRICE

£ 495.00



WIRELESS



NETWORK



INTERNET



Windows 10



LINUX



MAC

WL70 WI-FI BOOSTER

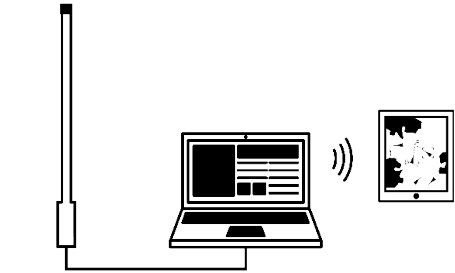

Typical system

“Just missing that network connection – the WL70 has a high gain 15dBm Antenna that sucks in the weakest of Wi-Fi signals allowing connection where ever you are in the marina. Ships with easy USB connection cable and integral 1” x 14TPI VHF thread mount”

KEY FEATURES

This compact all-in-one system features a very hi-gain (15dBm) Antenna with a 5m (16ft) USB cable. The Antenna measures 130cm (4.5ft) and should boost your Wi-Fi range to over 1.0 mile in perfect conditions.

Designed for quick and easy installation with the same standard 1” x 14TPI thread mount, as used by VHF and GPS Antennas, the WL70 is an ideal temporary or permanent mount Wi-Fi solution for boats.

The WL70 connects to an on board computer via a regular USB connection with a plug ‘n’ play driver disk supplied for Windows XP/Vista/7/8/10, LINUX and Mac OS X 10.6 to 10.10 operating systems. It supports 802.11b/g/n protocols as well as WEP and WPA/WPA2 encryption.

Even if your system already has Wi-Fi access, this can be disabled and you can take advantage of the superior range (and speed) that this system will offer.

Wi-Fi range depends on many local factors, but Digital Yacht has seen ranges of up to 1 mile with this low cost system. In general, using an internal Wi-Fi adaptor typically found on a notebook, you’ll be lucky to find the signal at the

end of the dock, so if you plan to access the internet whilst on board, the WL70 could be the solution for you.

SPECIFICATIONS

- New 802.11n high sensitivity Wi-Fi modem
- High gain 15dBm omni-directional Antenna (1.29m high)
- Will fit to a standard VHF type mount 1” x 14TPI thread (not supplied)
- USB bus powered via integral 5m (15’) cable
- Windows XP/Vista/7/8/10 compatible
- Mac OSX 10.4 to 10.10 (Yosemite) compatible
- Not compatible with Mac version above the 10.10 (it works with the iKConnect)

EXTRA APPLICATIONS



The combination of an iKConnect with a WL70 is an ideal way to connect your smartphone or tablet to the internet when in harbour. Part number of this bundle is: ZDIGWL70R

DIMENSIONS

130cm (4.5ft)
(H)

PART NUMBER

ZDIGWL70

UPC

081159830458

SUPPLIED WITH

Integral 1” x 14TPI thread mount, 5m (16ft) USB cable, Driver CD and User Manual

PRICE

£ 150.00



WIRELESS



USB



INTERNET



WINDOWS 10



LINUX



MAC

iKCONNECT WIFI ROUTER

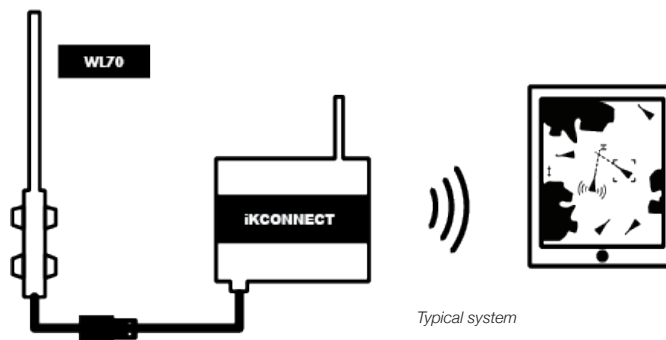

“The perfect mini router for our USB WL70 Long Range Wi-Fi adaptor or our latest iKommunicate Signal K gateway”

KEY FEATURES

iKConnect is a compact but powerful wireless router that provides a cost effective way to setup a wireless network on your boat. With direct connection to the boat's 12v DC, high gain 5dB Antenna and a small foot-print, simple to install black box, iKConnect can be easily fitted to any vessel.

Pre-configured and optimised for use with our USB WL70 Long Range Wi-Fi Antenna, the combination of an iKConnect with a WL70 is the lowest cost complete Wi-Fi solution that Digital Yacht have ever released and is an ideal way to connect your non-3G iPad or Android tablet to the internet when in harbour. With a simple web interface that controls the WL70 to scan and connect to the marina hotspot, iKConnect makes getting an internet connection on your boat a breeze.

iKConnect is also the perfect accessory for our latest iKommunicate Signal K gateway allowing mobile devices to wirelessly receive the Signal K or NMEA data anywhere on the boat. In fact the combination of iKConnect, iKommunicate and a WL70 allows the boat to have a single wireless network that provides both navigational data and internet access, without the hassle of

switching wireless networks.

For ultimate long range Wi-Fi connectivity simply swap the WL70 for Digital Yacht's top of the range WL510 system which seamlessly connects to the iKConnect WAN socket.

SPECIFICATIONS

- 12v DC Powered Wireless Router
- Simple to use Web Interface for setting up and connecting to hotspots
- Pre-configured and optimised for connection to Digital Yacht's latest WL70/510 long range Wi-Fi Adaptors
- Ideal accessory to our iKommunicate Gateway to get Wireless Signal K or NMEA data
- When connected to WL70/510, will allow the long range internet connection to be shared with everyone on board
- Creates an 802.11n wireless network onboard with full WEP/ WPA/ WPA2 encrypted password protection
- 5dB detachable Antenna
- USB interface for WL70 and a WAN connection for WL510
- Easy to install black box solution

DIMENSIONS

130mm x 75mm x 25mm
(L x W x D)

PART NUMBER

ZDIGIKC
UPC
081159830205

SUPPLIED WITH

1m Power cable, 1m Network Cable,
Wifi Antenna and User Manual

PRICE

£ 150.00



WIRELESS



NETWORK

iNAVCONNECT WIFI ROUTER

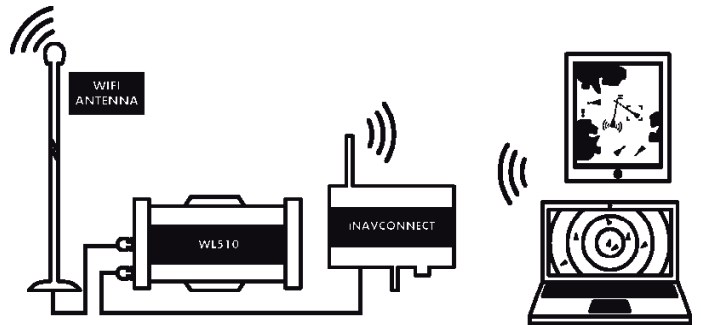

Typical system

“The perfect router for afloat with DC power, slick interface and support for multiple users. Data transfer and Fusion marine stereo remote control apps”

KEY FEATURES

iNAVConnect is an all in one solution for setting up a wireless network on your boat. With direct connection to the boat’s 12v or 24v DC, higher gain 5dB Antenna and a rugged IP54 black box, iNAVConnect can be easily fitted to any vessel.

iNavConnect also supports the Fusion app allowing a connected iPhone or iPad to control the Fusion stereo connected to the LAN on the iNavConnect.

Full integration with Digital Yacht’s latest WL510 long range Wi-Fi adaptor is also possible. Simply plug the WL510 in to the dedicated network socket and when you arrive in port and connect the WL510 to the marina’s hotspot, everyone on board will be able to share the long range internet connection.

SPECIFICATIONS

- 12/24v DC Powered Wireless Router
- Pre-configured and optimised for connection to Fusion Link
- Integrates with Digital Yacht’s latest WL510 long range Wi-Fi Adaptor
- When connected to WL510, will allow the long range internet connection to be shared with everyone on board
- Creates an 802.11n wireless network onboard with full WEP/WPA/WPA2 encrypted password protection
- Dual 5dB detachable Antenna
- Easy to install IP54 black box solution

DIMENSIONS

244mm x 150mm x 60.5mm
(L x W x D)

PART NUMBER

ZDIGINC
UPC
030955183640

SUPPLIED WITH

1m Power cable, 1m Network Cable,
Wifi Antennas and User Manual

PRICE

£ 150.00



WIRELESS



NETWORK

iNAVHUB WIFI ROUTER AND NMEA WIFI SERVER

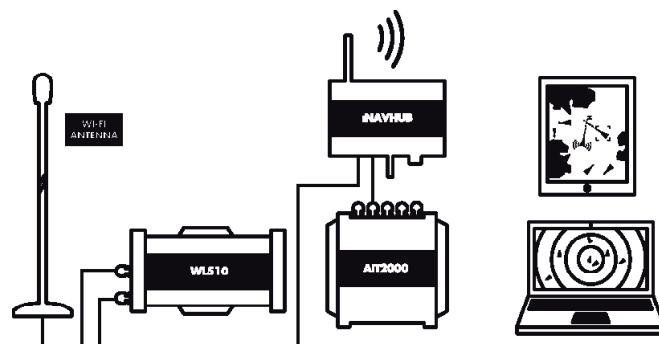

Typical system

“Your on board wireless hub with NMEA interface for navigation systems and WAN interface for internet access devices such as our WL510. Step on board and connect and you’ll have one network with all your data”

KEY FEATURES

iNAVHub combines wireless networking and wireless NMEA data transfer in one simple to install box. Similar to our popular iNavConnect product, it creates a wireless network onboard the boat that any wireless device can connect to.

Once connected, iPhones, iPads, PCs and Macs, can receive NMEA0183 data wirelessly for use in iNavX and other navigation apps, whilst also sharing the long range internet connection created by Digital Yacht’s WL510 product.

iNAVHub is designed to fully integrate with Digital Yacht’s latest WL510 long range Wi-Fi adaptor. Simply plug the WL510 into the dedicated network socket and when you arrive in port and connect the WL510 to the marina’s hotspot, and everyone on board will be able to share the long range internet connection.

SPECIFICATIONS

- 12/24v DC Powered Wireless Hub
- All-in-one solution for distributing your wireless internet and NMEA data
- Integrates with Digital Yacht’s latest WL510 long range Wi-Fi Adaptor
- When connected to WL510, will allow the long range internet connection to be shared with everyone on board
- Includes an NMEA interface that outputs NMEA0183 data wirelessly to multiple iPhones, iPads, PCs, etc. via UDP
- Creates an 802.11n wireless network onboard with full WEP/WPA/WPA2 encrypted password protection
- 5dB detachable Antenna
- Easy to install IP54 black box solution

EXTRA APPLICATIONS

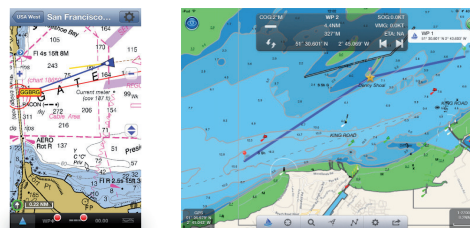

iNAVHub is the perfect partner to iNavX

DIMENSIONS

244mm x 150mm x 60.5mm
(L x W x D)

PART NUMBER

ZDIGINH

UPC

030955183855

SUPPLIED WITH

1m Power cable, 1m Network Cable,
Wifi Antenna and user Manual

PRICE

£ 300.00



WIRELESS



NETWORK



INTERFACE

DTV100 MARINE HDTV & FM ANTENNA



“A high performance, omni-directional HD TV Antenna that lets you start taking advantage of free to air HD digital TV signals”

KEY FEATURES

The DTV100 features a unique Antenna design that provides high gain, omni-directional reception of both vertically and horizontally polarized digital TV signals. Designed for marine use, with a pole mount or 1" x 14TPI thread mount adaptors, the Antenna is waterproof to IP68 and is constructed from ultra tough UV resistant ABS casing, designed to be permanently mounted on the boat.

With a 10m (33ft) low loss RG6 cable, that is terminated in a slim F-Type screw connector, for easy routing through tight spaces and secure and reliable connection to the DTV100 amplifier box.

The DTV100 features a variable amplifier (-7dB to +29dB) that can attenuate really strong signals for when you are close to a TV transmitter (to avoid distortion) and that can also significantly amplify weak signals when you are in more remote locations.

The amplifier can work from a 12v or 24v DC boat supply, features a useful on/off switch and has a green LED power indicator. The standard amplifier has one TV output and one FM radio output, while the optional dual channel amplifier can drive two TVs and an FM radio.

Most countries are now transmitting free to air digital TV channels (including many HD services) and the DTV100 ensures you get perfect reception where ever your boating may take you.

DTV200 also available with 20m antenna cable and dual out amplifier.

SPECIFICATIONS

- Very high performance omni-directional digital TV Antenna
- Waterproof to IP68, tough UV resistant casing that is designed for permanent mounting on the boat
- Global reception capability of latest digital DVB/HDTV signals
- Pole and 1" x 14TPI thread mount adaptors
- 1 x TV and 1 x FM radio outputs as standard
- Optional 2 x TV and 1 x FM radio amplifier accessory
- Variable gain below deck amplifier unit (-7dB to +29dB) with integral On/Off switch and power indicator
- 10m RG6 cable with slim and secure F-Type connector
- 12v or 24v DC operation (typicall 20-60mA)

DIMENSIONS

280mm diameter x 200mm high
(Dia x H)

PART NUMBER

ZDIGDTV100

ZDIGDTV200

UPC

081159830427

081159830786

SUPPLIED WITH

Pole and 1" x14TPI thread mount adaptors, 10m cable, amplifier, power lead and fixings. 20m cable for the DTV200

PRICE

£ 135.00

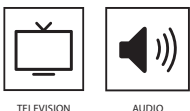

TELEVISION

AUDIO

AQUA COMPACT PRO PC

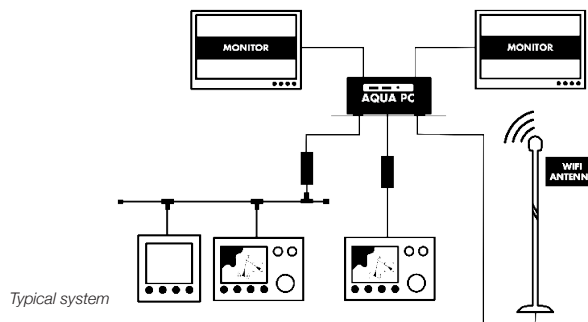

“Latest 5th generation Intel i3 with HD5500 graphics with the power to run MaxSea/Nobeltec TimeZero charting programs”

KEY FEATURES

When you need a more powerful PC to run the latest 3D TimeZero charting or weather routing software from companies like MaxSea and Nobeltec, the Aqua Compact Pro provides all of the processing and graphics power required in an ultra compact case that really does fit in the palm of your hand.

Featuring the latest 7th generation Intel Core i3 processor, 8GB of 1600MHz RAM, a 120GB solid state drive and with Windows 10 pre-installed, the Aqua Compact Pro is the perfect boat PC.

So why a PC on board? The number one, compelling reason to add a PC to your boat’s navigation and communication system is amazing value. Equipped with navigation software, a PC turns into a full function chart plotter. A PC also offers more powerful functionality than a dedicated MFD with the ability to install software for lots of applications from navigation to entertainment, email communications, weather and internet connectivity. PCs are also up-dateable as new applications become available.

Also available Aqua Compact Pro+ with Intel i7, 240GB drive and 8GB RAM. Ideal for use with 3D bathymetric and radar overlay systems

NOTE - the Aqua Compact Pro does have an internal fan and should be mounted in a location that has good air circulation.

LATEST WIRELESS TECHNOLOGY

The Aqua Compact Pro features the latest 802.11AC wireless adaptor that can operate on 2.4GHz or 5GHz and also supports BlueTooth. The internal wifi card can be configured to act as a wireless router for our entry level WL70 long range Wi-Fi adaptor, allowing multiple users to share the internet connection.

SPECIFICATIONS

- The perfect solution for demanding navigation applications like MaxSea/Nobeltec TimeZero even with radar and 3D integration
- Direct 12v DC Operation (8-19v input), approx 20W power consumption
- i3 7100U processor
- 8GB DDR4 2133MHz SO-DIMM memory and 120GB solid state drive
- Dual display outputs – full size HDMI and USB C
- Bluetooth 4.2 and Dual Band WiFi built in
- 4 x USB 3 ports with charging mode on front panel port
- Front panel mounted audio jack for audio in/out
- Windows 10 operating system
- Built in mic for Cortana speech control and recognition – voice control is here!
- Micro SD slot – ideal for Navionic’s cards with our SmarterTrack PC navigation software
- Just 115mm x 110mm x 50mm
- Easy installation with supplied mounting bracket
- LINUX or Windows 8 OS option at no extra charge

DIMENSIONS

115mm x 110mm x 50mm
(L x W x H)

PART NUMBER

ZDIGAQCP
ZDIGAQCPPL

UPC

081159830502
081159830632

SUPPLIED WITH

Power cable, Mounting bracket,
Software CD and Manual

PRICE

£ 825.00



WINDOWS 10



SOLID STATE DRIVE



USB



NETWORK



LOW POWER

USB TO NMEA ADAPTOR

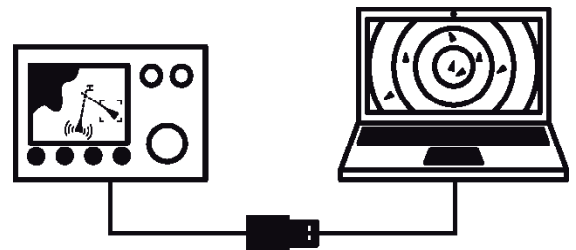

Typical system

“Get NMEA data into your PC or MAC with this super stable interface”

KEY FEATURES

The NMEA to USB Adaptor works on PCs, Macs and Linux computers, and converts NMEA 0183 data, used by many marine systems, into a USB format that can be plugged into most modern computers.

The adaptor is a bi-directional device so data can be sent to and from systems and supports traditional 4800 baud data or the higher speed 38400 baud rate used by AIS systems. LEDs show data being received and transmitted which helps with interfacing issues and all the electronics are encapsulated into the connector. The device creates a virtual COM port on the PC which navigation and charting software can use to read NMEA data. Multiple adaptors can be connected if necessary which effectively allow any number of NMEA ports to be created on your PC.

The device ships with a multi platform driver CD so it can be used on PCs, MACs and even Linux based systems. If you're using the device with an AIS, you'll get a bonus as SmarterTrack Lite AIS viewing software is included on the CD - effectively turning your PC into an AIS target display.

SPECIFICATIONS

- Converts NMEA0183 into USB so that your computer can read the data
- Bidirectional data conversion
- Use with our GPS150 for PC integration
- Low cost simple solution
- More than one adaptor can be fitted to the computer
- 4800, 9600, 38400 and 115200 baud compatible
- Built-in indicator lights flash to show data is being received and transmitted
- Easy plug and play connection to most computers
- Comes with a driver CD and a free copy of SmarterTrack Lite AIS software

DIMENSIONS

1.8m cable

PART NUMBER

ZDIGUSBNMEA

UPC

030955183671

SUPPLIED WITH

1.8m Cable, Manual and CD

PRICE

£ 35.00



USB



INTERFACE



Windows 10



LINUX



MAC

SMARTERTRACK LITE SOFTWARE

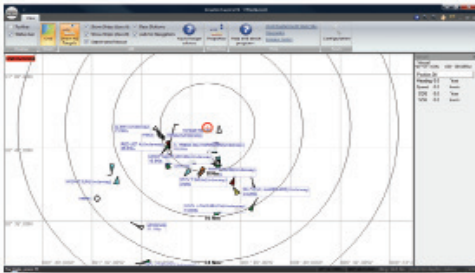

“Supplied free with our AIS systems, this is a great PC viewer for AIS systems”

KEY FEATURES

SmarterTrack LITE is a simple, but effective graphical AIS display program for PCs. The data collected by AIS units is meaningless without some sort of graphical display that shows where the AIS targets are in the real world, relative to your vessel.

SmarterTrack LITE does just this by plotting all surrounding AIS targets on a world map or, as you zoom in, on a blank radar type screen with variable range rings.

Designed to give customers an immediate taste of what AIS is all about, SmarterTrack LITE can then be upgraded to the full version as and when required.

AIS support includes; colour coded targets, user selectable labelling of targets, target course lines and fast AIS Information recovery, making it the ideal introduction to AIS software on the market.

SmarterTrack LITE can be used on any PC running a Windows XP/ Vista/7/8 operating system.

SPECIFICATIONS

- Simple graphical AIS display software for PCs
- Plots all detected AIS targets on world map
- Automatically switches to AIS “Radar” type display as you zoom in
- Colour coded AIS Targets with course lines
- Each AIS target shown with user selectable label
- Allows easy programming of Class A Transponder voyage data
- Will display wireless NMEA 0183 data from Digital Yacht’s iAIS, WLN10 and Boatranet products
- Can be upgraded to full SmarterTrack package

DIMENSIONS

N/A

PART NUMBER

ZDIGSTLTE

UPC

N/A

SUPPLIED WITH

N/A

PRICE

FREE



Windows 10

SMARTERTRACK 2018 SOFTWARE



Navionics charting



Weather overlay



Sophisticated AIS overlay

“Easy to use PC navigation software compatible with Navionics charts. Powerful features and AIS enhanced displays”

KEY FEATURES

SmarterTrack is the ideal PC navigation software for anyone who has a dedicated chart plotter that uses Navionics Gold and Platinum chart cartridges or who is new to electronic charting and wants simple to use PC navigation software with good AIS support.

Planning at home, monitoring from the chart table or as a self contained independent backup system, SmarterTrack turns your PC in to an invaluable navigation tool that will display your GPS position and the location of all the surrounding AIS targets on the accurate and detailed Navionics electronic charts.

AIS support includes; colour coded targets, user selectable labelling of targets, fully configurable CPA and TCPA alarms, visual indication of CPA, AIS targets drawn to scale and many other other settings and features that make this software ideal for displaying AIS data. Entering the route you wish to sail, checking the tides, overlaying weather (GRIB files), confirming depths or nav-aids on the chart and a whole host of other routine navigational tasks can be performed simply and effortlessly with SmarterTrack.

SmarterTrack now also supports Navionics's Sonar charts which give highly detailed sub-sea information and additional depth contours generated

from user supplied local data. SmarterTrack can also utilise the internal wifi adaptor on Aqua PCs to support apps like Splashtop which allow remote display mirroring on iPads and tablets – perfect as a 2nd station display. On this latest version, Navionics's charts can be copied to the PC hard drive allowing charts to be shared between plotter and PC with no additional costs. Navionics's charts are widely used by Lowrance, Raymarine, Simrad, B&G and Humminbird plotters so SmarterTrack makes an ideal partner to an on board plotter.

SPECIFICATIONS

- Simple yet powerful PC Navigation software
- Supports Navionics's Gold or Platinum chart cartridges – NOTE ONLY charting features supported not 3D capability of Platinum
- Now compatible with Navionics Smart Charts
- Excellent AIS support
- Full set of configurable alarms
- Displays tidal height and tidal flow data
- Optimum departure time capability from tidal data
- All route and waypoint data created on SmarterTrack can be transferred to your dedicated chart plotter
- Displays all NMEA 0183 instrument data
- Allows import of downloaded weather GRIB files
- Will display wireless NMEA 0183 data from Digital Yacht's iAIS, WLN10 and Boatranet products

DIMENSIONS

N/A

PART NUMBER

ZDIGSTPCN

UPC

738435472566

SUPPLIED WITH

N/A

PRICE

£ 150.00



DVD



NAVIONICS

NavLink UK MAC

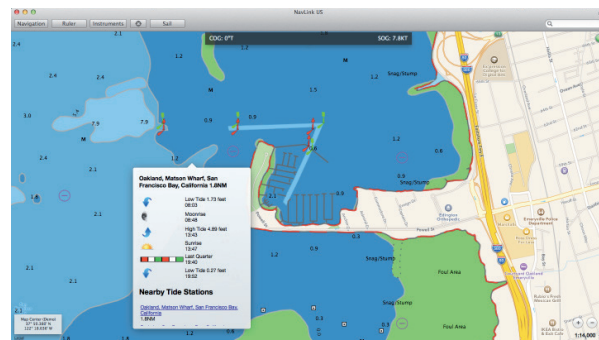

KEY FEATURES

NavLink MAC is an Apple MAC based electronic charting and navigation package which turns a MacBook into a full function chart plotter. The application comes complete with highly detailed UK Hydrographic Office vector charts for the UK & Ireland and allows real time positioning, tracking and routing. Simply create a route with a click of the mouse to quickly and easily get bearing, distance and ETA information to your destination. AIS targets can also be overlaid onto the electronic charting. Charts can be zoomed and panned using intuitive finger gestures on the MAC track pad.

The MAC will require a GPS connection for location and optional connection to AIS if an AIS overlay of targets is required. Digital Yacht's range of GPS sensors or their low cost USB-NMEA adaptor can be utilised to connect the MAC to the boat's GPS/AIS system. Alternatively, for a wire free solution, NavLink supports a connection via wifi to any of Digital Yacht's NMEA to wireless devices such as iAIS and the WLN10.

The seamless charts feature incredible detail as they are the official digitised versions of the UKHO chart data charts and show buoys, nav aids, depth contours, wrecks, spot depths, restrictions etc. It also supports "drill down" data so an object such as a buoy can be queried for its characteristics. Weather buoys are supported for local weather conditions (an internet connection is required for this live data) and a tidal atlas is

included. NavLink has been designed to take full advantage of the MACs simplicity of operation and the clarity of the retina displays on Apple's latest products.

SPECIFICATIONS

- Detailed vector UKHO charts covering the all of the UK + Ireland
- GPS and AIS interfaces via USB or WiFi (compatible with Digital Yacht's NMEA to wifi devices and NMEA to USB adaptor)
- Superfast screen redraws and intuitive panning and zooming thanks to the MacBook's OS
- A-B chart ruler
- Drill down chart information
- Create waypoints and routes and share routes with others
- Export and share routes with the NavLink iOS app
- Weather buoy and tidal data
- Real time GPS tracking
- AIS target overlays with CPA and TCPA alarms
- Chart Printing

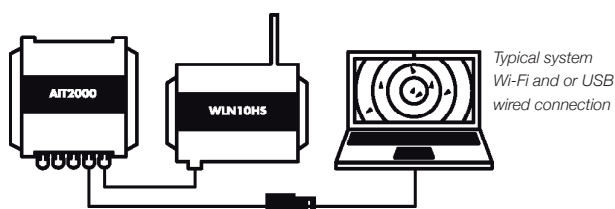

DIMENSIONS

N/A

PART NUMBER

N/A

SUPPLIED WITH

N/A

PRICE

Consult the Mac App store.



MAC



NAVLINK

NavLink is a low cost app designed for use with an iPhone or iPad. It transforms your iPad into a full function chart plotter with detailed electronic charts and an overlay of your boat's position, AIS, track and heading.

IAIS

iAIS is a simple AIS target plotter designed for use with Digital Yachts AIS WiFi receiver or any of our other Wireless NMEA products if they are connected to an AIS system. iAIS is a fun and interesting App for anyone onboard a boat fitted with one of our Wireless AIS systems, allowing other vessels to be seen, tracked and identified.

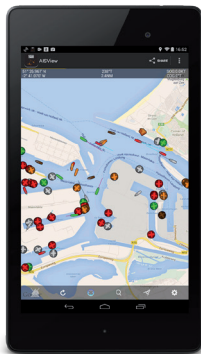

AISVIEW

AISView is a smart application for Android tablet & smartphone to display AIS target information onto a background Google map. AISView is designed to wirelessly connect into your boat's AIS system via any of Digital Yacht's NMEA to Wifi

OUTBOARDVIEW

Turn your Android device in to an electronic dashboard for your boat's NMEA2000 enabled outboard. OutBoardView is designed to work with Digital Yacht's iKommunicate Signal K Gateway, this app will receive engine data such as RPM, temperature, pressure, fuel flow, etc. and display it all in a modern electronic dashboard.



WINDSENSE

Turn your Android device in to a 360° Wind and Close Haul Wind Instrument with this free app. This app will both display the wind angle and wind speed data from the WND100 mast head unit, but also allows you to calibrate any angular offset that may have occurred when you fitted the transducer to the top of the mast.



MA800 Passive GPS Antenna (P/No. X500.391) is supplied with all Digital Yacht AIS Transponders and is an ideal replacement Antenna for many makes of GPS receivers and chart plotters. Will work from a 3v or 5v pre-amplifier voltage.

Deck mounting bracket (P/No. ZCELE179F) that is supplied with our WL510 long range Wi-Fi Antenna for and is a useful accessory for any commercial VHF, Wi-Fi or other marine Antenna that has the less common 1.25" Pipe Thread mount.



Popular adaptor that allows an Antenna with a 1.25" pipe thread mount, such as the WL510 Antenna, to be mounted on a standard 1" x 14TPI thread VHF mount (P/No. ZCELN280F).

Powerful AIS Tuned commercial grade VHF Antenna that will give you maximum AIS range (P/No. ZDIGCELCX4A). Has an N-Type female connector in the base of the Antenna and we recommend using this with low loss 50 ohm coax cable such as RG-213 for best performance, particularly on long cable runs.



Compact wired USB keyboard for use with our Aqua range of PCs (P/No. ZDIGKB05). Features an integral two port USB Hub so that you can easily plug in a dongle or USB Memory Stick.



Tel: +44 (0) 117 955 4474
www.digitalyacht.co.uk
Edition 1 | 2018

6 Farleigh Court
Old Weston Rd
Flax Bourton
Somerset BS48 1UR
United Kingdom

Designed and manufactured in



Follow our daily news feed at www.digitalyacht.net