



# Product Introduction

Digital Deep Sea CLA2000 Class A AIS Transponder

November 2019 Digital Deep Sea UK Tel + 44 1179 55 44 74

[www.digitaldeepsea.com](http://www.digitaldeepsea.com)

**CLA2000**

Part Number: ZDIGCLA2000

UPC: 081159830823

SRP €2195.00 ex vat

# Introduction



Dear Partner

Digital Yacht's new CLA2000 is the ultimate SOLAS and inland waterway globally approved Class A AIS transceiver. Water and weather proof to IP67, it has a full integrated 5" hi-res colour display supporting a wide range of functionality including electronic chart navigation with optional C-Map MAX charting and AIS target management.

Proven, superior real world AIS message receive and transmit and message processing performance is delivered by advanced core SDR AIS technology. This state of the art technology ensures you see more targets, more of the time and at maximum range.

The CLA2000 will find applications on SOLAS mandated vessels over 300GRT as well as workboats, rescue services, inland waterways users, RIBs, large yachts and any user wanting premium AIS performance and safety

The Digital Deep Sea team  
TEL + 44 1179 55 44 74



# Features

- Globally approved Class A AIS transponder
- High resolution, 800 x 480 pixel 5" colour display (MKD) with easy to use, fast user interface
- Bracket or flush mount – waterproof to IPX7
- Integrated GPS with external antenna or utilise external NMEA feed (user selectable)
- 3 x NMEA 0183 interface (bi-directional for plotter, ECDIS, radar etc)
- 3 x sensor input ports (eg BlueBoard, external GNSS, gyro etc)
- NMEA 2000 interface
- Built in SD card slot for software updates, AIS data port logging or C-Map MAX mapping capability with optional C-Map data card
- Built in wi-fi for connection to iPads and tablets for wireless navigation
- Sophisticated AIS SART MOB alarm and display capability
- User programmable alarms for CPA and TCPA
- Advanced filtering of targets
- External alarm and remote silence switch capability







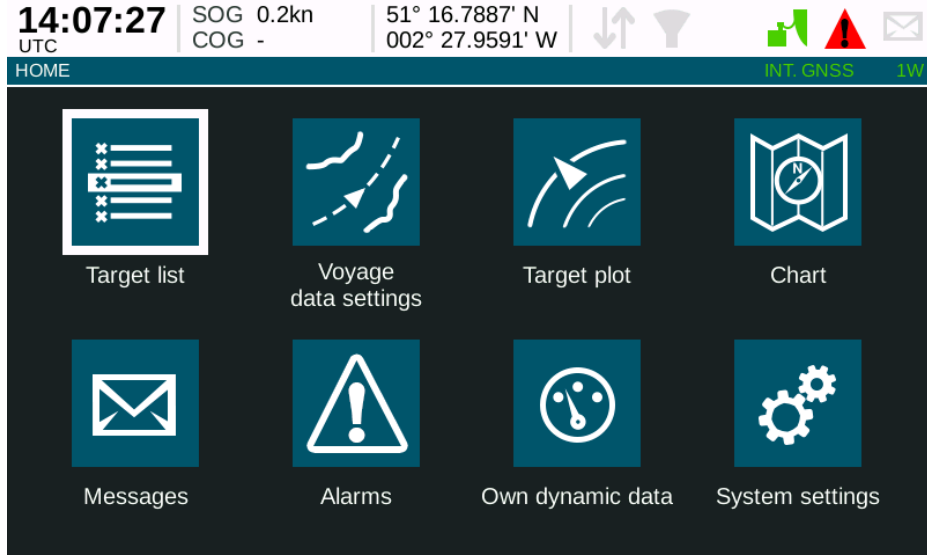



**DIGITAL  
DEEP SEA**

# Displays









Easy to use, icon based user interface makes selecting function and entering data easy using rotary knob as well as cursor button control – even in rough conditions

Target list provides name, type, range, bearing, CPA and TCPA filterable list with drill down static vessel data at the push of a button. Icons make target identification easy

-  AIS Class A
-  AIS Class B
-  AIS AtoN
-  Virtual AIS AtoN
-  Off Position AIS AtoN
-  AIS SAR Aircraft
-  Base station
-  AIS SART

15:09:30 UTC | SOG 0.5kn | COG 150.0° | 51° 25.7810' N | 002° 16.3219' W | 

TARGET LIST							EXT. GNSS
Name/MMSI	Range	Bearing	CPA	TCPA	Type	Age	
SART Test	11.6NM	218.9°	-	-		1m 50s	
666000666	11.6NM	218.9°	10.8NM	8hr 18m		0m 21s	
CONTAINER APOLLO 3	11.6NM	218.8°	10.8NM	8hr 21m		0m 1s	
PP TEST 40	11.6NM	218.9°	10.8NM	8hr 20m		0m 10s	
PP TEST 31	11.6NM	218.9°	10.8NM	8hr 20m		5m 10s	
PP TEST 47	11.6NM	218.9°	-	-		2m 13s	
CONTAINER CARBON ...	11.6NM	218.9°	10.8NM	8hr 20m		2m 43s	

Visible: 20 Filtered out: 0

# Displays

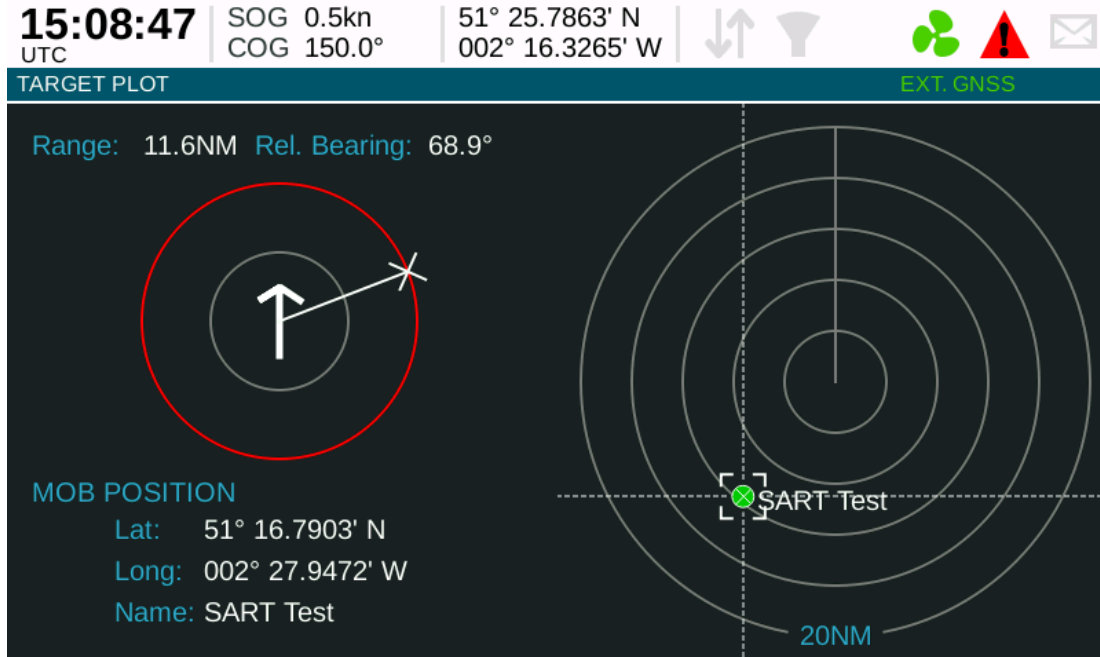

Plot display shows easy visualisation of target bearing, relative bearing and distance

Built in base mapping for easy referencing of target positions. Optional detailed mapping with C-Map MAX charting on micro SD card

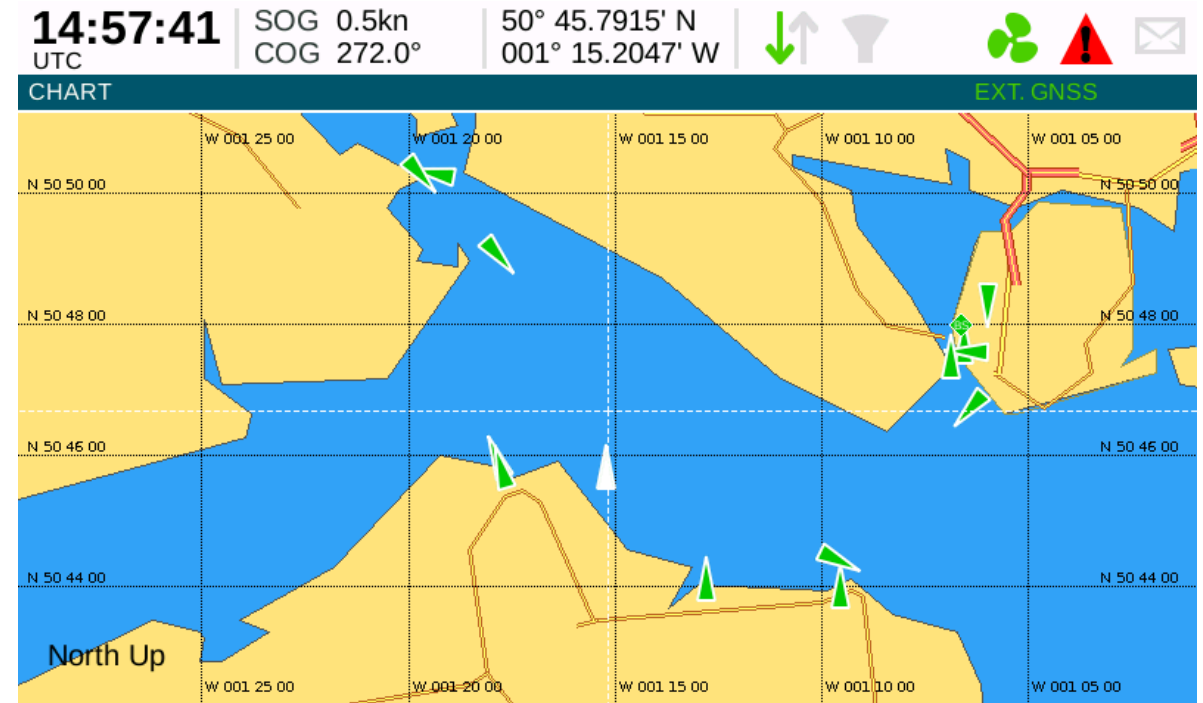

# Displays

The screenshot shows a navigation software interface. At the top, it displays the time 11:38:13 UTC, SOG 30.4kn, COG 11.1°, and coordinates 51° 16.6903' N, 002° 27.9423' W. Below this is a 'TARGET LIST' table with columns for Name/MMSI, Range, Bearing, CPA, TCPA, Type, and Age. A dialog box is overlaid on the table, titled 'CPA/TCPA alert', with the message 'A target (992012211) has breached the configured CPA/TCPA limits'. The dialog has two buttons: 'Accept all' and 'OK'. The table shows several targets, including NUTS N BOLTS, ATON 9, CS UNII 2, ATON, CARBON, VERIFY2, and COOL THREADS.

Name/MMSI	Range	Bearing	CPA	TCPA	Type	Age
NUTS N BOLTS					+	2m 14s
ATON 9					◇	1m 32s
CS UNII 2					◇	0m 8s
ATON					+	0m 3s
CARBON					◇	1m 11s
VERIFY2					↑	0m 36s
COOL THREADS	0.1INM	234.0			+	2m 16s

Visible: 15 Filtered out: 0

User configurable alarms for CPA (closest point of approach) and TCPA (time to CPA)

Optional detailed mapping with C-Map MAX data cards. Choose from north up or course up presentations

The screenshot shows a navigation software interface displaying a detailed map. At the top, it displays the time 14:17:37 UTC + 1hr, SOG 0.5kn, COG 166.0°, and coordinates 50° 47.0968' N, 001° 14.8166' W. Below this is a 'CHART' section with a detailed map of a coastal area, showing various navigational aids, depth contours, and landmarks. The map is oriented 'Course Up'. The interface includes a 'TARGET LIST' table and a 'CPA/TCPA alert' dialog box, similar to the first screenshot. The map shows various navigational aids, including ATONs, buoys, and depth contours. The map is oriented 'Course Up'.

# Displays

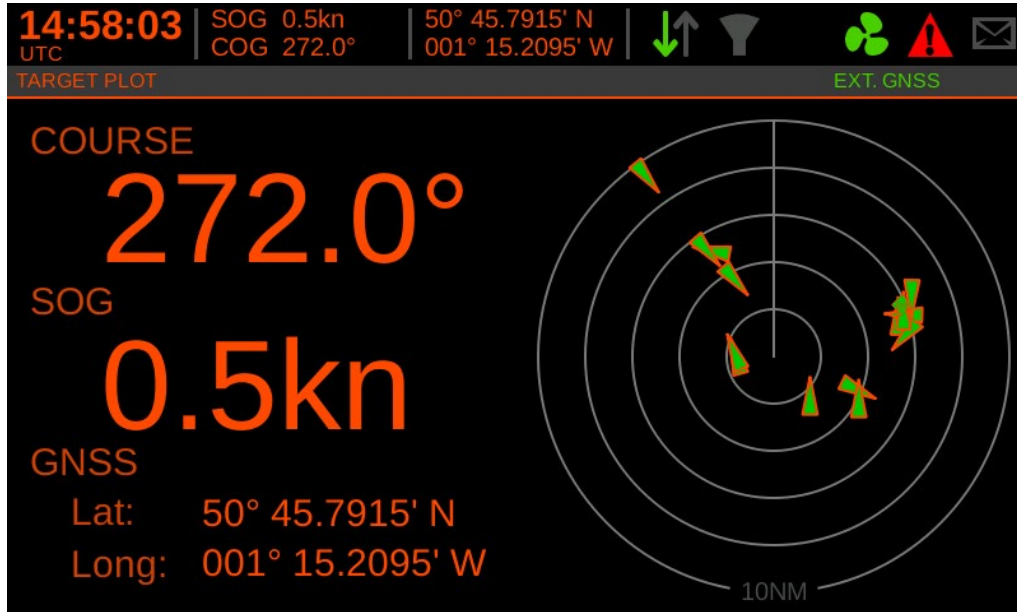

Standard target plot mode with large display of key navigation data

Choose from day or night colour palettes

Advanced GNSS position display showing source and satellite status. User can select external or internal GNSS positioning source

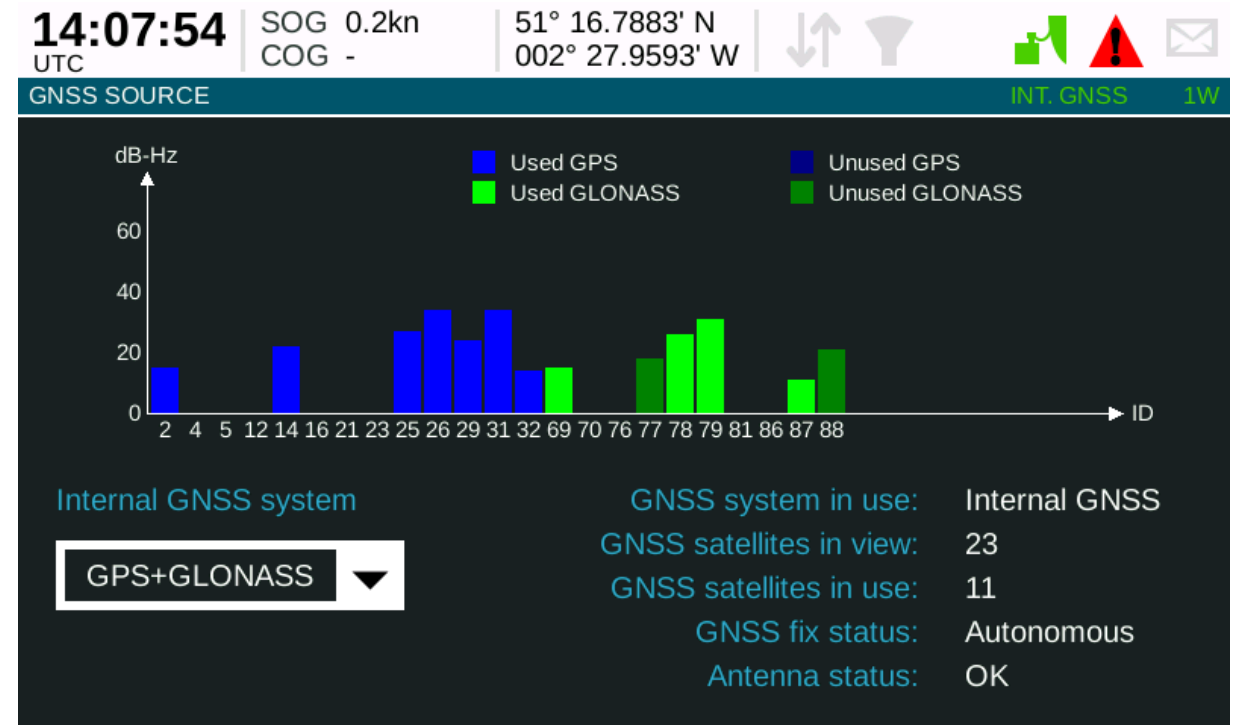

# Advanced AIS SART/MOB Capability

The CLA2000 has optimised software for detecting AIS SART and MOB devices with a dedicated icon for this class of AIS. An automatic alarm is activated on detection of an AIS SART beacon activation. The target plot display will also calculate relative bearing of the device for easy visualisation of the target and rescue

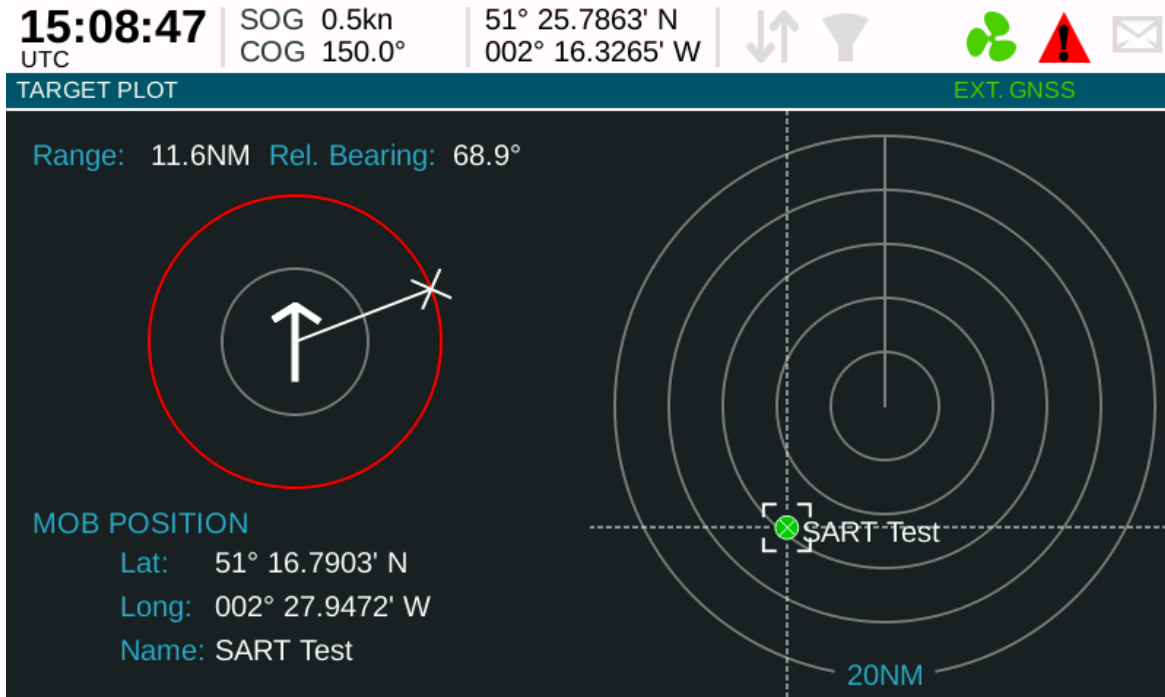



# SD Data Card Port

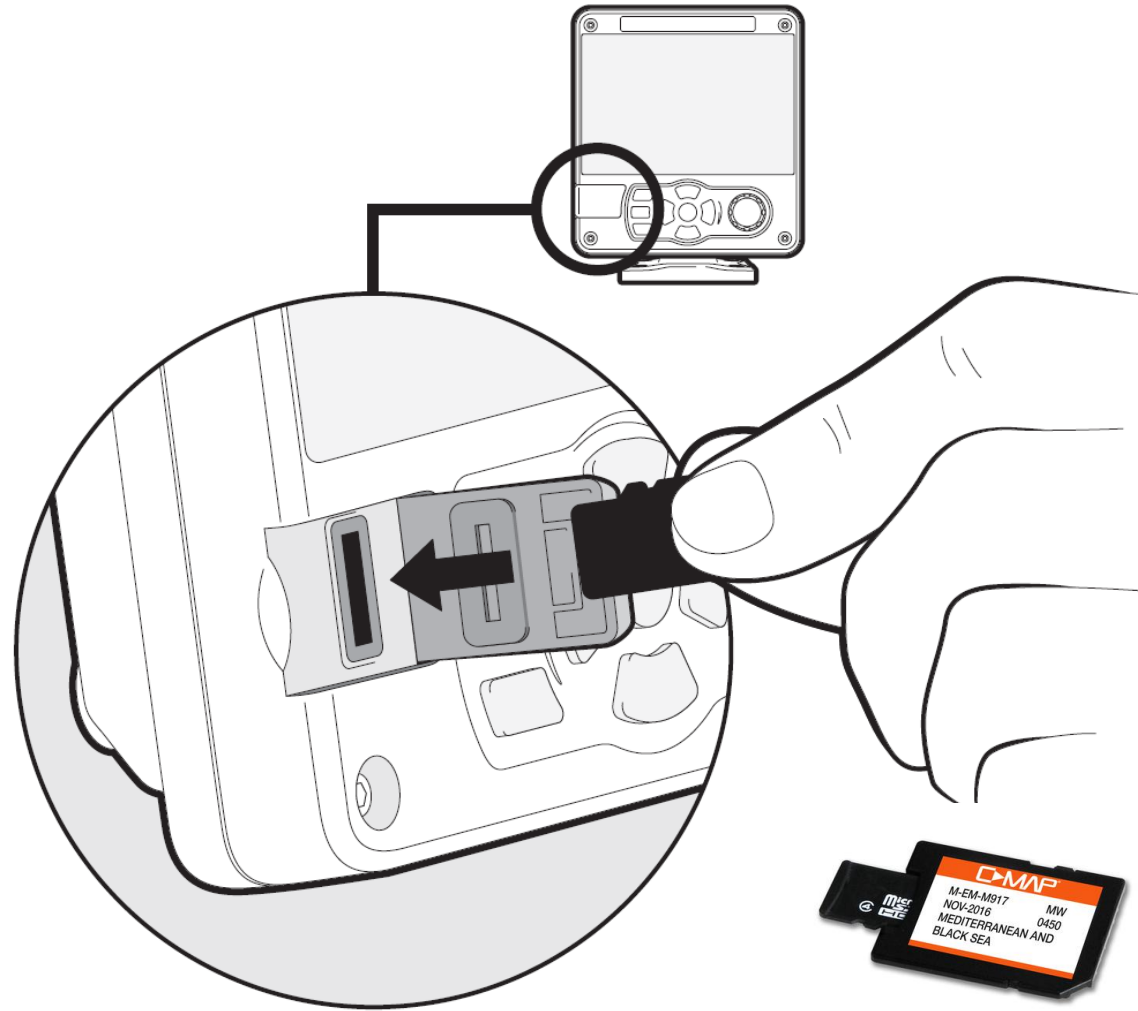

The CLA2000 is fitted with a micro SD card reader located behind a waterproof cover on the front panel. This can support software updates, data logging of AIS and position data to a blank card as well as compatibility with C-Map MAX charting cards for optional detailed back ground charting

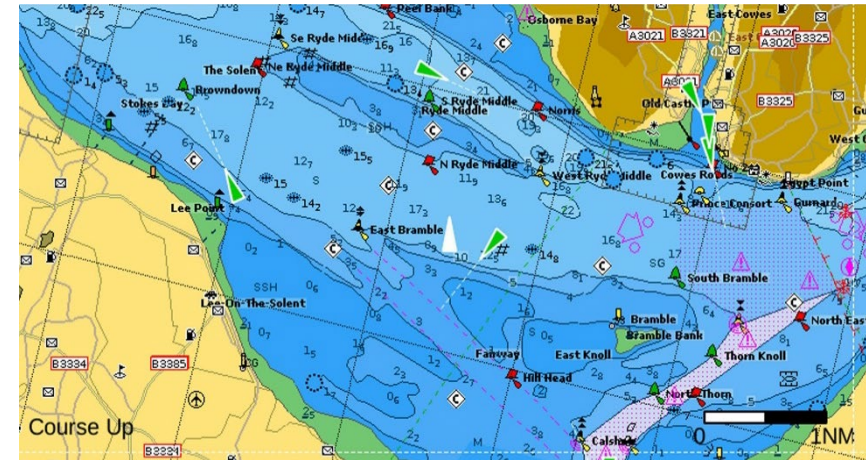

# Wireless Interface

The CLA2000 has an integrated wireless interface for sending AIS and position data to smart phones, tablets, PCs and MACs for use with 3<sup>rd</sup> party charting and navigation apps. It supports client mode where it can connect to an existing wireless network or AP mode where devices can connect directly to the CLA2000. Up to 5 simultaneous/connected devices are possible.

There is support for TCP and UDP connectivity and the user can set IP and port address details. WiFi can also be disabled



# Rear Panel Connections

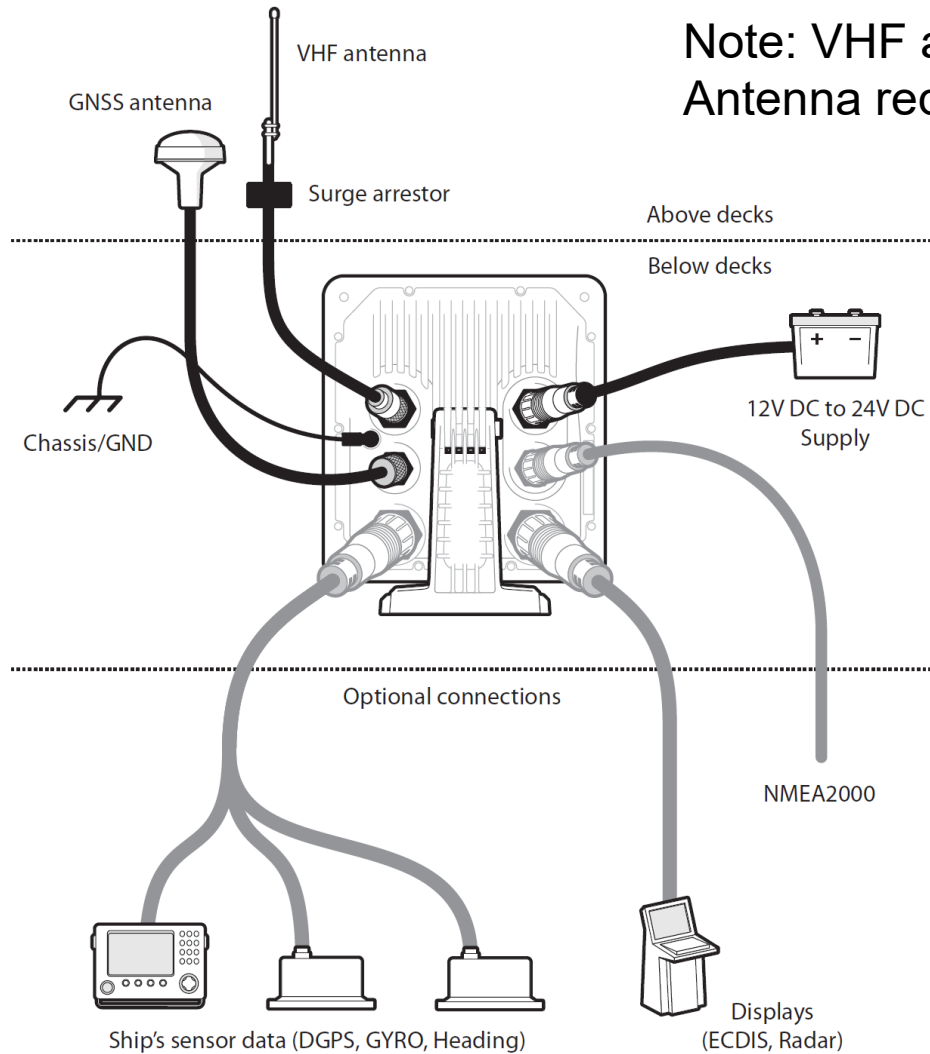

Note: VHF antenna or optional surge arrestor not supplied  
Antenna requires PL259 style connector for CLA2000

14 way and 18 way interface cables for sensor and external interfacing

# What's Included

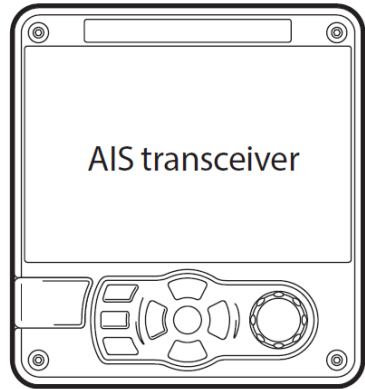

AIS transceiver

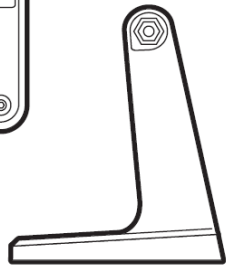

Mounting bracket

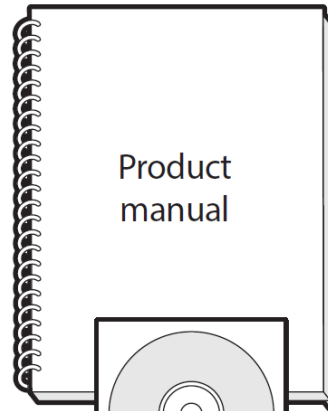

Product manual

Product CD

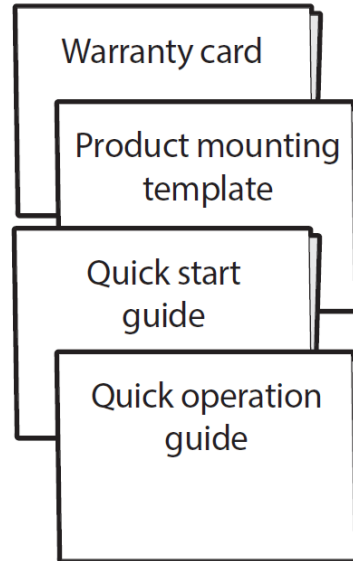

Warranty card

Product mounting template

Quick start guide

Quick operation guide

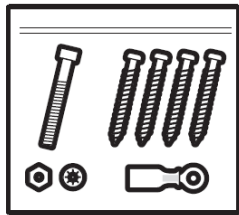

Fixings



Power cable



14 way data cable



18 way data cable

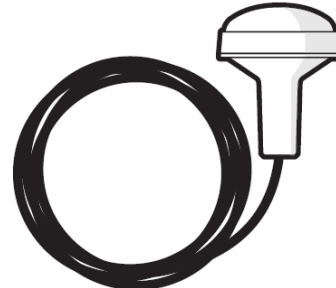

GNSS Antenna Cable Assy

- 14 way data cable has connections for:
- 3 X Sensor input (eg external GNSS, gyro)
  - Blue Board for IW operation
  - Silence switch

- 18 way data cable has connections for:
- 3 x Bi-Directional NMEA (one configurable for pilot plug interface if required)
  - External alarm
  - LR DGPS

**NB! VHF antenna not supplied**

# Dimensions & Power

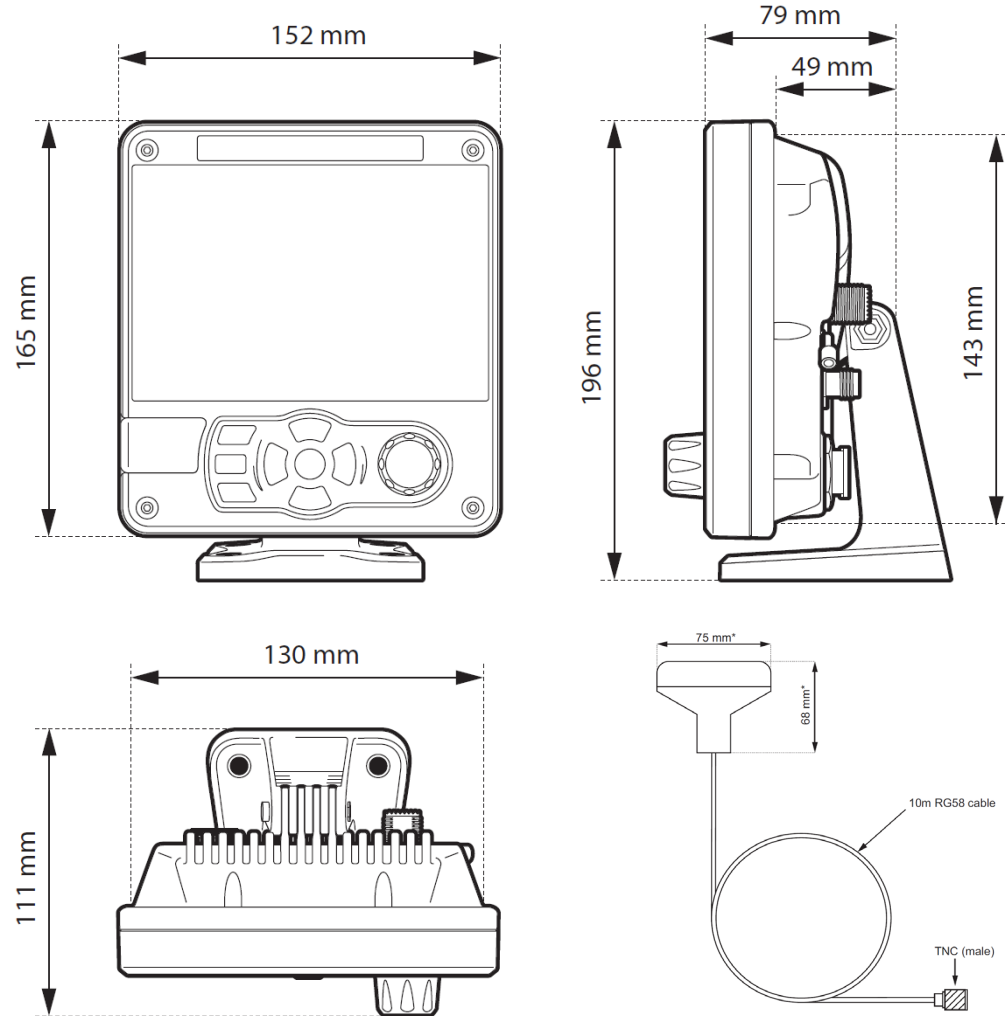

Operating temperature range	-15°C to +55°C
Maximum operating humidity	90% at +40°C, non-condensing
Water ingress rating	IPx6, IPx7

Supply voltage	12VDC to 24VDC (absolute min 10.8V, absolute max 31.2 V)
Power consumption	< 12W
Current consumption @12 VDC supply	0.9A typical, 6.0A peak
Current consumption @24 VDC supply	0.5A typical, 4.0A peak

Note bracket can be removed for flush mounting.

Weight 1.5kg